

ALLEN & HEATH®



XONE:PX5®

USER GUIDE

Publication AP10733_2

Page left intentionally blank.

Limited One Year Manufacturer's Warranty

Allen & Heath warrants the Allen & Heath - branded hardware product and accessories contained in the original packaging ("**Allen & Heath Product**") against defects in materials and workmanship when used in accordance with Allen & Heath's user manuals, technical specifications and other Allen & Heath product published guidelines for a period of ONE (1) YEAR from the date of original purchase by the end-user purchaser ("**Warranty Period**").

This warranty does not apply to any non-Allen & Heath branded hardware products or any software, even if packaged or sold with Allen & Heath hardware.

Please refer to the licensing agreement accompanying the software for details of your rights with respect to the use of software ("EULA").

Details of the EULA, warranty policy and other useful information can be found on the Allen & Heath website: www.allen-heath.com/legal.

Repair or replacement under the terms of the warranty does not provide right to extension or renewal of the warranty period. Repair or direct replacement of the product under the terms of this warranty may be fulfilled with functionally equivalent service exchange units.

This warranty is not transferable. This warranty will be the purchaser's sole and exclusive remedy and neither Allen & Heath nor its approved service centres shall be liable for any incidental or consequential damages or breach of any express or implied warranty of this product.

Conditions of Warranty

The equipment has not been subject to misuse either intended or accidental, neglect, or alteration other than as described in the User Guide or Service Manual, or approved by Allen & Heath.

Any necessary adjustment, alteration or repair has been carried out by an authorised Allen & Heath distributor or agent.

The defective unit is to be returned carriage prepaid to the place of purchase, an authorised Allen & Heath distributor or agent with proof of purchase. Please discuss this with the distributor or the agent before shipping. If the unit is to be repaired in a different country to that of its purchase the repair may take longer than normal, whilst the warranty is confirmed and parts are sourced. Units returned should be packed in the original carton to avoid transit damage.

DISCLAIMER: Allen & Heath shall not be liable for the loss of any saved/stored data in products that are either repaired or replaced.

Check with your Allen & Heath distributor or agent for any additional warranty information which may apply. If further assistance is required please contact Allen & Heath Ltd.



Xone:PX5 complies with the European Electromagnetic Compatibility directives 2014/30/EU and the European Low Voltage directives 2014/35/EU.

Any changes or modifications to the equipment not approved by Allen & Heath could void the compliance of the product and therefore the users authority to operate it.

XONE:PX5 User Guide API0733 Issue 1

Copyright © 2016 Allen & Heath Limited. All rights reserved

Allen & Heath Limited

Kernick Industrial Estate, Penryn, Cornwall, TR10 9LU, UK

<http://www.allen-heath.com>

INTRODUCTION

Congratulations on purchasing the Allen & Heath Xone:PX5 DJ mixer.

Combining the signature warm analogue Xone sound with class leading digital connectivity, the Xone:PX5 breathes life and soul into electronic music performance. The built-in XONE:FX technology offers new levels of manipulation with our new Xone:Xcite FX suite of performance focused delays, reverbs, modulators, flangers and distorters, which are all assignable through simple hands-on control for fine tuning effects and expressing the DJ's inner creativity.

Xone:PX5 is a 4+1 channel mixer, equipped with the legendary analogue XONE:VCF (Voltage Controlled Filter), 3 band isolator EQ on all channels, and intuitive layout.

The versatile Send/Return feature enables connection of external effects hardware with both Send/Return (Line level, or Hi-Z) and Master Insert mode connections, and equips Xone:PX5 for numerous enhanced setup scenarios. Each channel has its own dedicated send control for external effects processing and can also be routed to the internal XONE:FX engine.

Connect your laptop or computer to the premium 20, 24Bit/96kHz, Hi-Speed USB internal soundcard for easy integration into digital DJ workflows, plus connection via X:LINK to Xone:K Series controllers for expanded software application MIDI control.

The cross-fader has three switchable curve settings for blending or scratching styles and can be easily replaced, or upgraded to the innoFADER Pro2 for ultimate cross-fader performance.

No matter what your mixing style, the Xone:PX5 combines a modern approach to DJing with all the tools required for creating your own individual sound.

CONTENTS

To ensure you get the maximum benefit from the mixer, please spend a few minutes familiarizing yourself with all of the controls and setup procedures outlined in this user guide.

For further information, please refer to the additional details available on our website, or contact our Product Support team

www.allen-heath.com/xonepx5

<http://support.allen-heath.com>

Warranty	3
Introduction.....	4
Contents	5
Packed Items.....	6
Setup Examples	7
Rear Connectors.....	9
Mic / USB / Line Input, Channel A.....	12
Phono / USB / Line Input, Channels 1 - 4	13
Cross-fader	15
Headphone Section.....	16
Master Section	17
Voltage Controlled Filter Section.....	18
XONE:FX Control Section Overview	19
FX Library Reference	21
BPM Detection.....	22
Xone:Sync	23
Driver Installation (PC)	26
USB Soundcard (Defaults)	28
MIDI Control.....	29
MIDI Note Implementation.....	35
Connecting X:Link Controllers	36
Timecode Setup;Traktor Scratch Pro 2...	37
Recording a Mix;Traktor Scratch Pro 2...	40
Block Diagram.....	41
Specifications	42
Panel Drawings.....	44
Filter Reference	46
Operating Levels.....	47
Earthing.....	48
Replacing the Faders	49

PACKED ITEMS

Check that you have received the following:

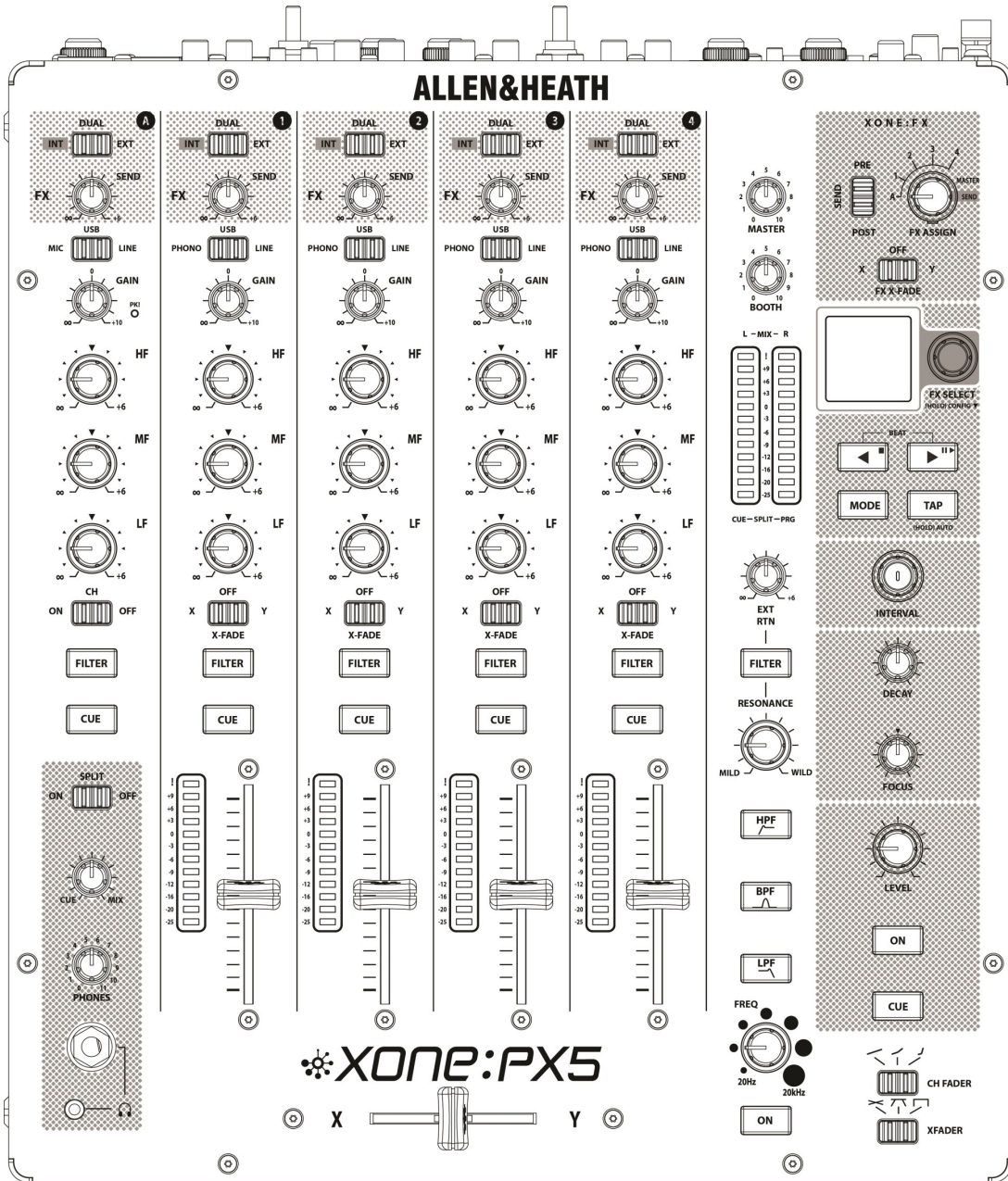

Xone:PX5 mixer

**IMPORTANT SAFETY INSTRUCTIONS
PLEASE READ THESE INSTRUCTIONS**

CAUTION

Read the instructions carefully before using the mixer. Do not touch the mixer when it is powered on. Do not touch the mixer when it is powered on. Do not touch the mixer when it is powered on.

ATTENTION

Ne touchez pas le mixer quand il est sous tension. Ne touchez pas le mixer quand il est sous tension. Ne touchez pas le mixer quand il est sous tension.

WARNING: To reduce the risk of fire or electric shock do not expose this apparatus to rain or moisture.

All the safety and operating instructions should be read before the apparatus is operated.

- RETAIN INSTRUCTIONS:** The safety and operating instructions should be retained for future reference.
- NEED WARNING:** All warnings on the apparatus and in the operating instructions should be observed.
- FOLLOW INSTRUCTIONS:** All operating and use instructions should be followed.
- WATER & MOISTURE:** The apparatus should not be exposed to dripping or splashing and should never be placed in a location where water can be spilled over it.
- VENTILATION:** The apparatus should be placed on a surface which allows for adequate ventilation. Do not block the ventilation openings. Do not place the apparatus on a soft surface such as a bed or sofa. Do not place the apparatus on a surface which is not designed for the apparatus.
- HEAT:** The apparatus should be placed in a well-ventilated area. Do not place the apparatus in a location where it is exposed to heat.
- POTENTIAL FIRE HAZARD:** The apparatus should be placed in a well-ventilated area. Do not place the apparatus in a location where it is exposed to heat.
- POWER CORD PROTECTION:** The power cord should be protected from damage. Do not place the apparatus in a location where it is exposed to damage.
- ATTACHMENTS:** Only use attachments that are recommended by the manufacturer.
- CLEANING:** The apparatus should be cleaned with a soft, dry cloth.
- NON-LIVE PARTS:** The power cord of the apparatus should be unplugged from the outlet when not in use for a long period of time.
- OBJECTS & LIQUID ENTRY:** Do not place objects on the apparatus. Do not place the apparatus in a location where it is exposed to liquid.

Safety Sheet

Important!

Read this sheet **BEFORE** starting.
Retain for future reference.

Spare knobs and buttons

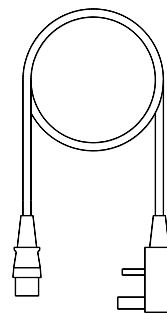
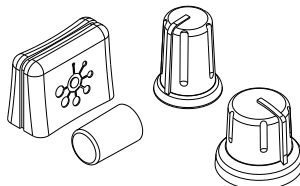

Mains Lead

Check that the correct mains plug is fitted.

SETUP EXAMPLES - CLASSIC

CLASSIC ANALOGUE MIX : VINYL ONLY

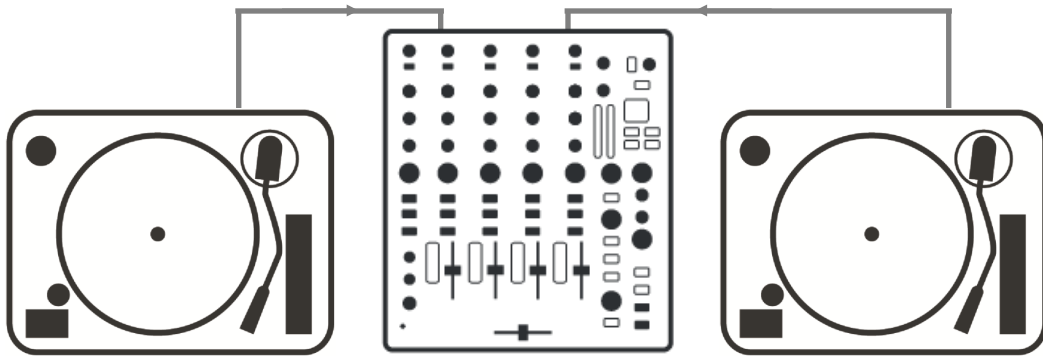

CLASSIC DIGITAL MIX : CD / MEDIA PLAYER + HARDWARE FX
MEDIA PLAYER (RCA) / EXT FX (SND-RTN)

KEY: CABLE & CONNECTOR TYPES

- PHONO/LINE (RCA)
- USB (TYPE A-B)
- EXT FX (TRS, 1/4" JACK)
- X:LINK (CAT-5, RJ-45)
- INSERT (TRS, Y LEAD)
- MIDI SYNC (SPIN DIN)
- MIC (XLR)

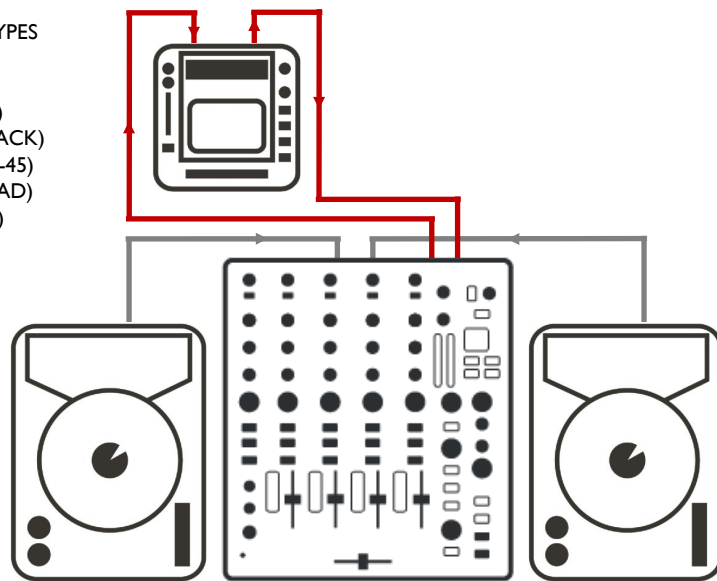

CLASSIC HYBRID MIX : ANALOGUE + DIGITAL + MC
VINYL & MEDIA PLAYER (RCA) / LAPTOP (USB) / MIC (XLR)

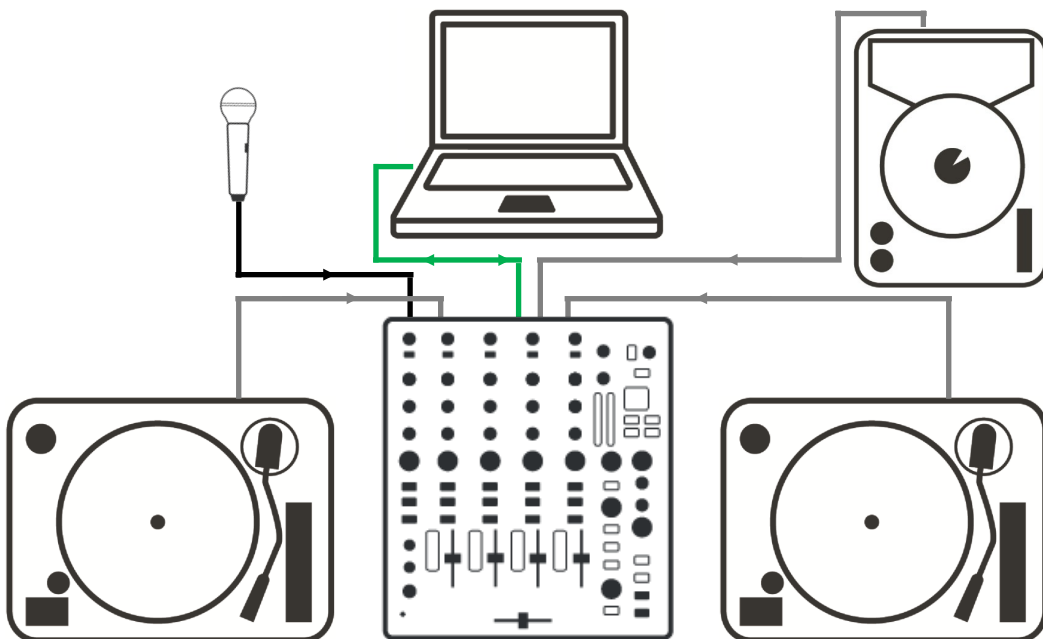

SETUP EXAMPLES - ADVANCED

ADVANCED HYBRID MIX : ANALOGUE + DIGITAL + MIDI SYNC + CONTROL
 VINYL & MEDIA PLAYER (RCA) / LAPTOP (USB) / EXT FX (INSERT + SND-RTN) / X:LINK (RJ-45)

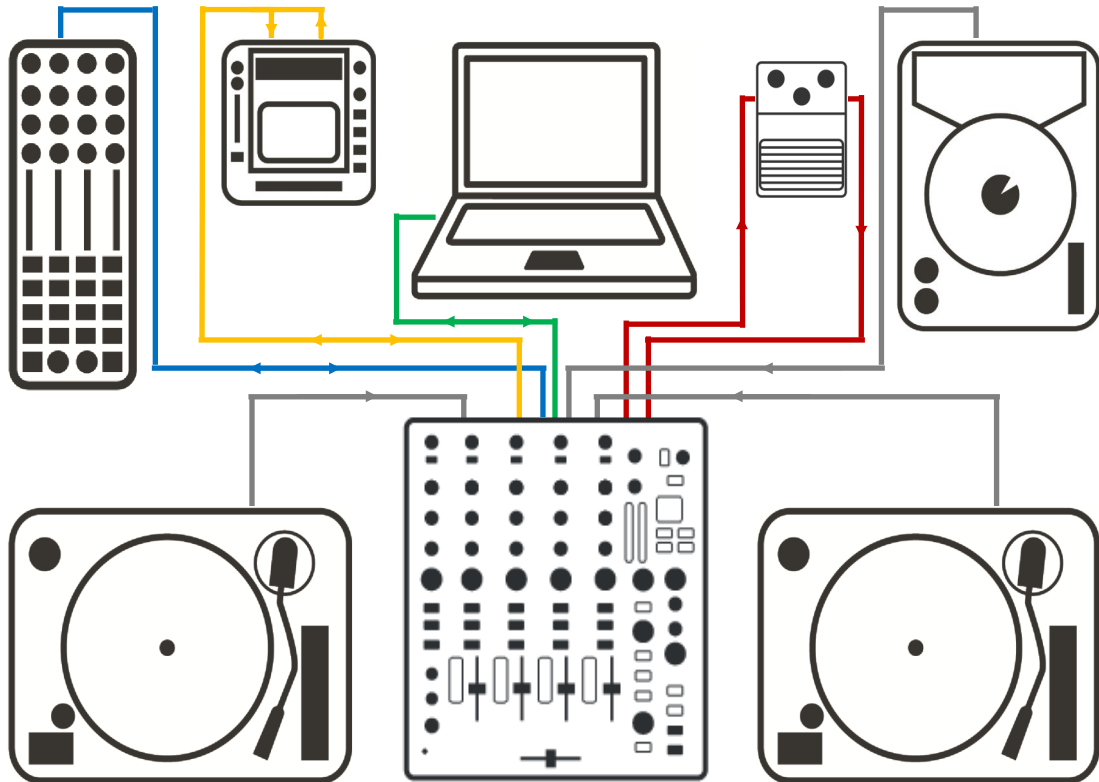

'FULLY LOADED' HYBRID MIX : ANALOGUE + DIGITAL + HARDWARE FX + MIDI SYNC + CONTROL
 VINYL & MEDIA PLAYER (RCA) / LAPTOP (USB) / EXT FX (INSERT + SND-RTN)
 MIDI SYNC (5PIN DIN) / X:LINK (RJ-45)

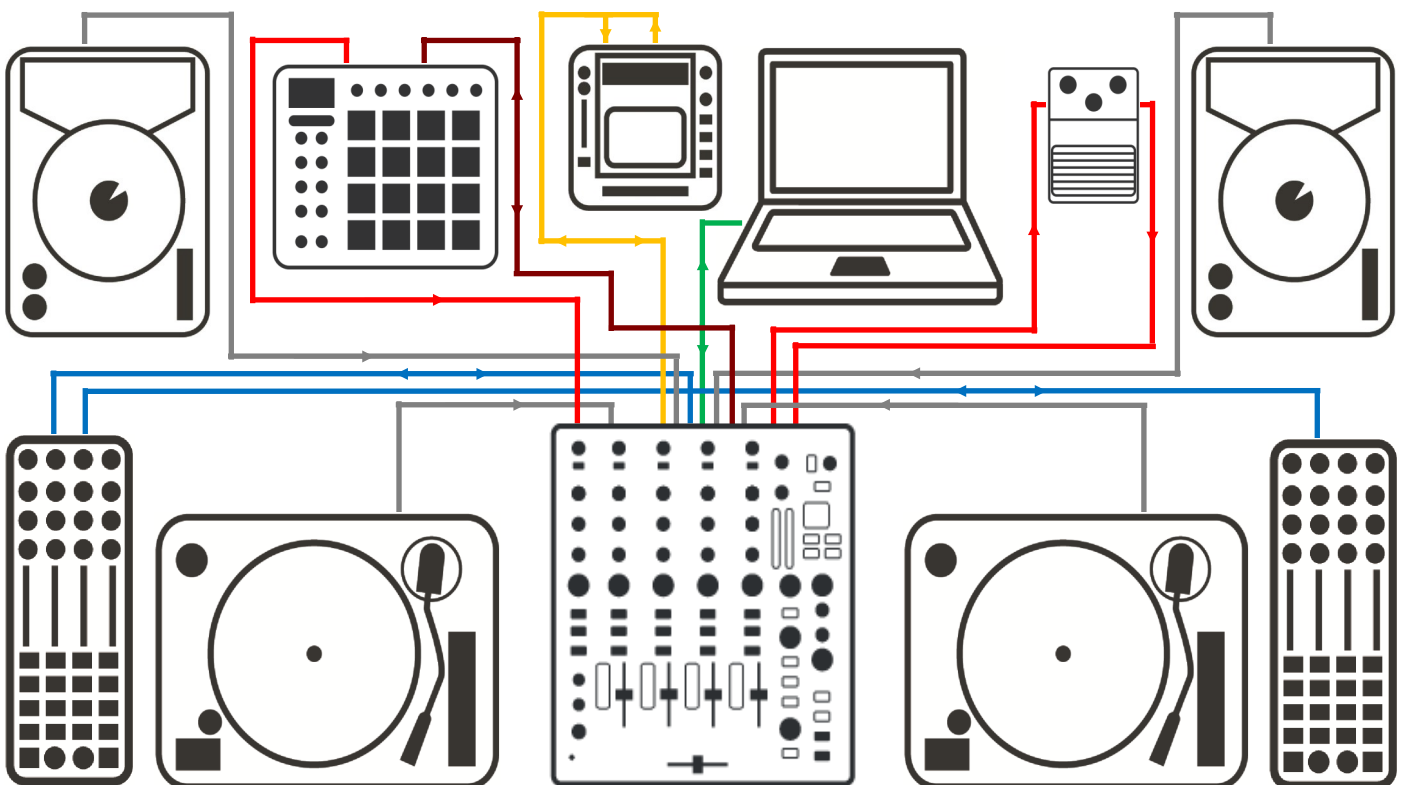

REAR CONNECTORS

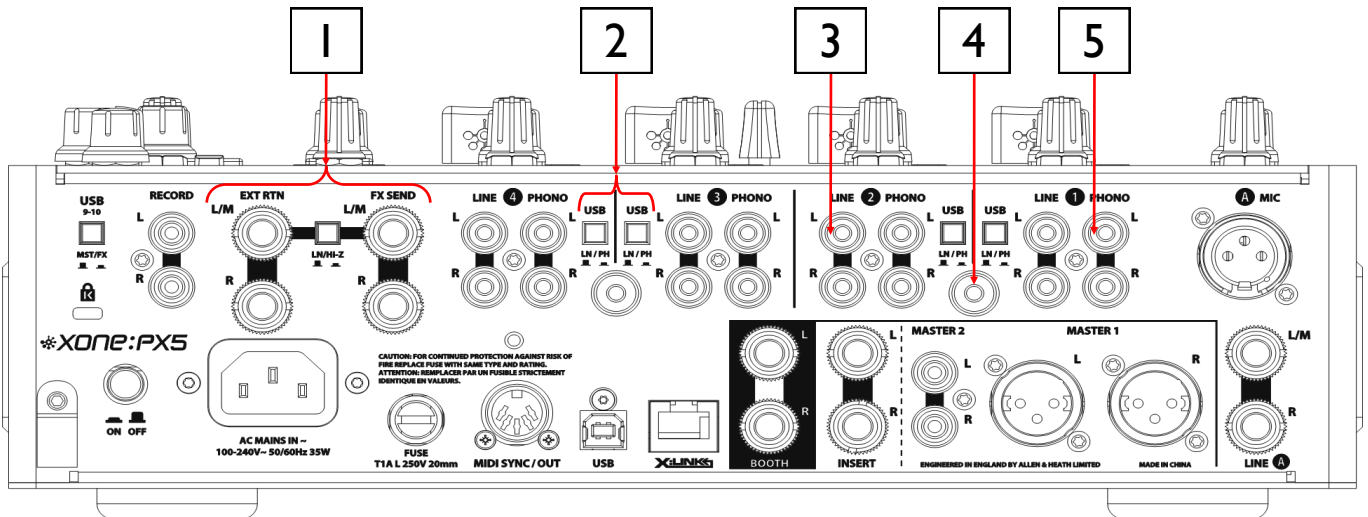

1 External Effects Connectors, EXT RTN / LINE/Hi-Z / FX SEND

Balanced (TRS) 1/4" Jack. Connect external effects device **outputs** to EXT RTN inputs and use EXT RTN control to adjust FX signal level sent to main LR MIX or XONE:VCF.

Set input impedance for external effects between LN (suitable for Line level inputs), or Hi-Z (suitable for guitar effects pedals and legacy hardware).

Connect your external effects hardware **inputs** to FX SEND and **outputs** to EXT RTN. Use FX SEND controls to send Channel audio to the external effects device.

2 USB LINE / PHONO Select Switches, CH 1 - 4

Set CH 1 - 4 USB SND to LN (for Line level) or PH (for RIAA level) signal input to internal soundcard. For CD / Vinyl timecode control, or to record Channel input via USB.

3 LINE Inputs, CH 1 - 4

Unbalanced (RCA). Connect stereo LINE level media players to the LINE input.

Do **not** connect turntables requiring RIAA equalisation.

You can also connect to LINE level jack sources using RCA to 1/4" Jack adapters.

Avoid using low grade cables such as those often supplied with domestic equipment as these can quickly prove unreliable in use.

4 Chassis Earth Terminals

2 x Screw terminals are provided for connecting the earth straps from turntables to prevent ground hum.

5 PHONO Inputs, CH 1 - 4

Unbalanced (RCA). Plug in turntables with magnetic cartridges requiring RIAA equalisation. For non-RIAA turntables plug into the LINE input instead.

Do **not** plug in LINE level sources to the PHONO Inputs as these will overload the preamp and cause severe, high level, distortion.

REAR CONNECTORS continued

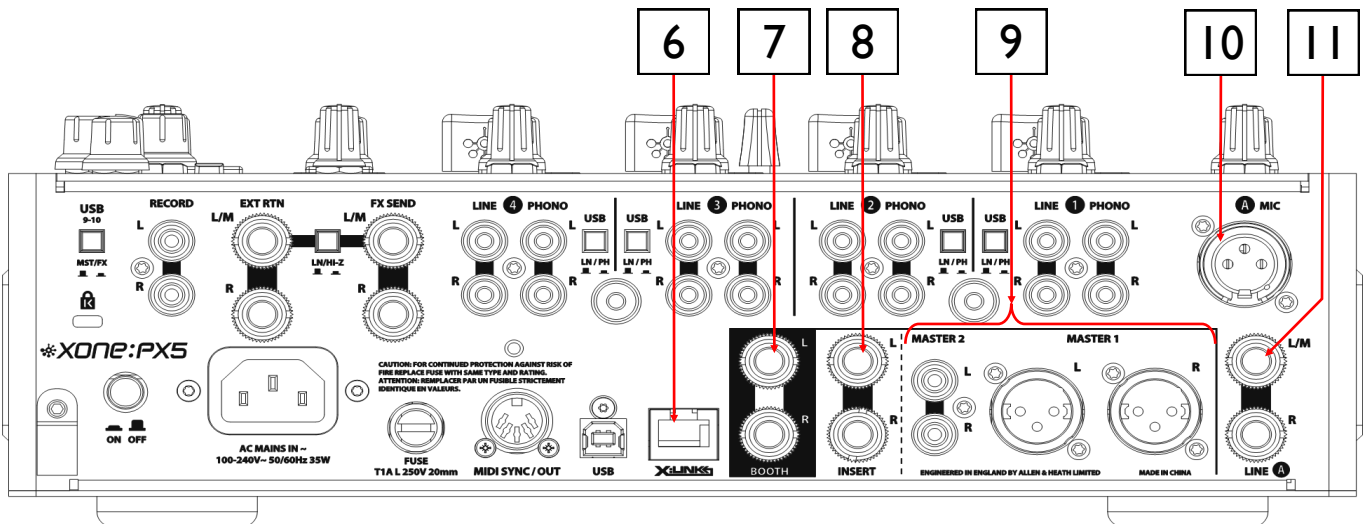

6 X:Link

Cat-5 Ethernet (RJ-45). Connect Xone:K Series Controllers to the Xone:PX5 mixer to expand software application MIDI control and to save using USB ports on your computer.

7 BOOTH Outputs

Balanced (TRS) 1/4" Jack. LINE level stereo output feed to DJ's local monitor.

8 MASTER INSERT

Unbalanced (TRS) 1/4" Jack. Provides INSERT points for LR MIX output to connect hardware dynamics processors such as a limiter, compressor, or graphic equaliser. Or connect external hardware in-line with LR MIX outputs for external MASTER INSERT FX. Use Insert patch cable (Y lead), wired; Tip=Send, Ring=Return, Sleeve=Ground.

9 MASTER Outputs

Master1. Balanced (XLR). The main stereo LR MIX outputs that feeds the club PA system, or balanced active speakers. Wired; Pin1=Ground, Pin2=Hot(+), Pin3=Cold(-).

Master2. Unbalanced (RCA). Alternative stereo LR MIX output to feed unbalanced active speakers, or consumer type amplifiers.

10 MIC Input, CH A

Balanced (XLR). Use a good quality low impedance dynamic mic, wired; Pin1=Ground, Pin2=Hot (+), Pin3=Cold(-). Do not use high impedance or unbalanced microphones, or condenser mics requiring phantom power.

11 LINE Inputs, CH A

Balanced (TRS) 1/4" Jack. Connect auxiliary or balanced LINE level music sources to the CH A LINE input. Connect mono sources to the L/M socket.

REAR CONNECTORS continued

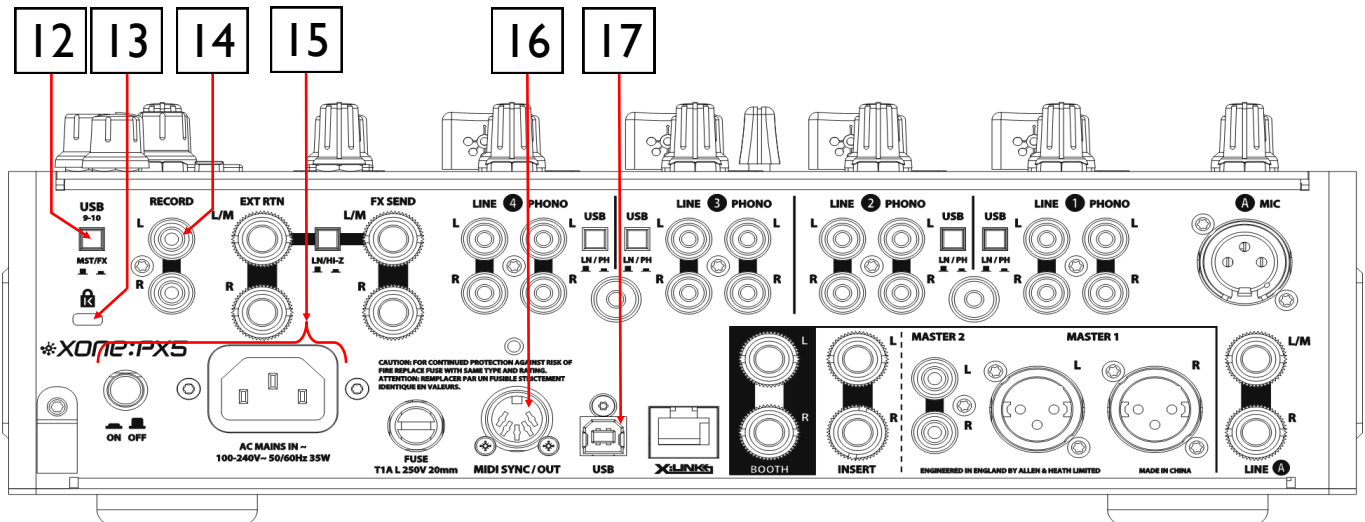

12 USB 9-10 Send Select Switch

Set CH9-10 USB SND to MST or FX to route LR MIX, or FX SEND output via USB.
For pre-MASTER level stereo LR MIX recording to computer, or using FX SEND for software effects plug-ins.

13 K-Slot

Security slot to connect locking, Kensington® type, anti-theft cable.

14 RECORD Outputs

Unbalanced (RCA).
Pre-MASTER level, LR MIX output for connection to external hardware recording devices.

15 AC Mains Input

Connect (supplied) IEC cable with moulded mains plug compatible to local AC mains supply.
Turn AC supply to the mixer ON / OFF

Check the correct IEC 'mains' lead with moulded plug has been supplied with your mixer.
The internal power supply accepts mains voltages within the range 100-240V without changing any fuses or settings.

Ensure the IEC mains plug is pressed fully into the rear panel socket **before** switching ON.

NOTE: It is standard practice to turn connected power amplifiers, or active speakers, *down* or OFF **before** switching mains power to the mixer ON or OFF. This prevents any potential damage to speaker systems due to switch-on transients.

16 MIDI SYNC / OUT

5pin DIN.
MIDI Clock and MIDI Tx (transmit) signal output for syncing to external MIDI hardware.

17 USB Soundcard

USB (Type A).
20 Channel (5 Stereo IN / 5 Stereo OUT), 24Bit/96kHz, Hi-Speed USB internal soundcard.
Mac OS X CoreAudio/CoreMIDI class compliant. ASIO® driver support for Windows® PC.

MIC / USB / LINE INPUT CHANNEL A

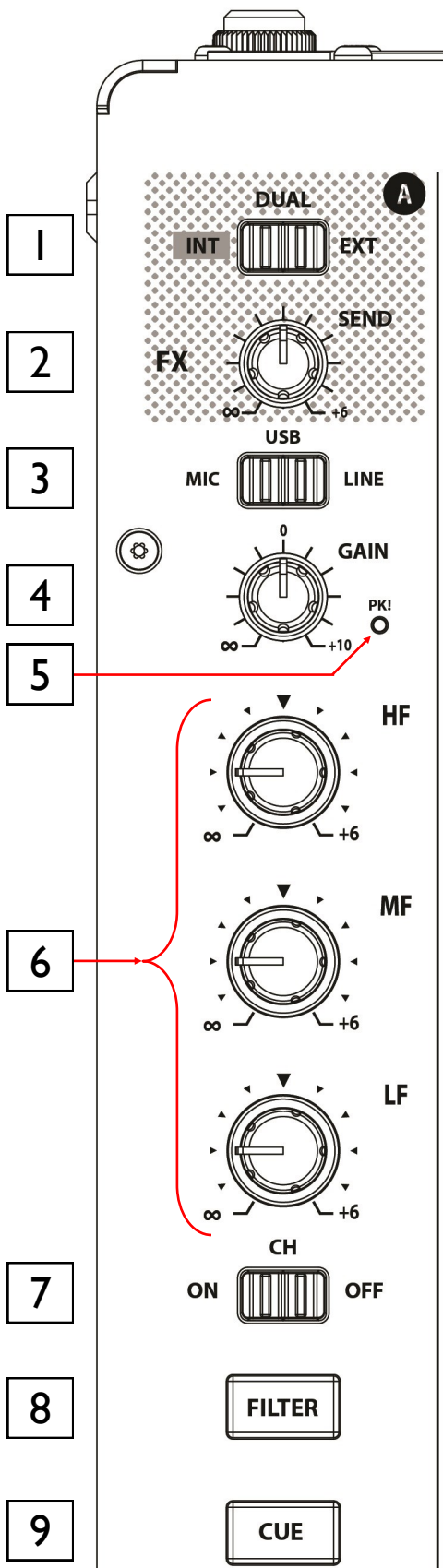

1 Channel FX Mode Select Switch

Selects option for Channel FX SEND routing to; INT, EXT, or DUAL. For SEND to internal XONE:FX engine, external effects hardware connected via FX SEND / EXT RTN, or to both for simultaneous use with internal and external effects.

2 FX SEND Control

Controls the amount of Channel audio sent to the XONE:FX bus and/or external effects hardware connected via FX SEND / EXT RTN on the rear panel.

3 MIC / USB / LINE Input Select Switch

Switch CH A input between XLR MIC, CH5 USB RTN soundcard input, or auxiliary CH A TRS LINE sources.

4 Channel GAIN Control

Adjusts the Channel input sensitivity to compensate for different audio signal source levels. $-\infty/+10$ dB.

5 PK! Input Signal Level LED, CH A

If the PK! LED is illuminated, turn the Channel GAIN level *down*.

6 Channel Equalizer

Each main Channel is equipped with a powerful 3 band isolator EQ, providing a controlled +6dB boost when fully clockwise and full attenuation ('Total Kill') on each band when fully anti-clockwise.

Centre/cut-off frequencies are set at:

HF	3.5kHz	(High Frequency, <i>treble</i>)
MF	1.2KHz	(Mid Frequency)
LF	400Hz	(Low Frequency, <i>bass</i>)

7 Channel ON/OFF Switch

Turns the Channel ON or OFF, allowing audio to be routed to the main LR MIX. Useful if an un-switched microphone is used to easily bring vocals in and out of a mix. This does not affect CH A signal output to CUE.

8 Channel FILTER Select Switches

Press to route post-GAIN / post-EQ level Channel audio to the XONE:VCF.

9 Channel Cue Switch

Press to listen to the Channel pre-LR MIX audio level from PHONES and BOOTH DJ monitor outputs and to view its level on the main (MIX) Meters. Press again to deselect CUE.

PHONO / USB / LINE INPUT CHANNELS 1 - 4

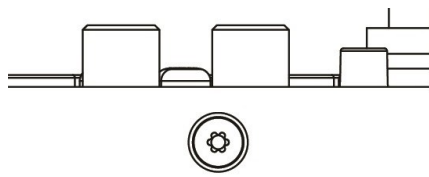

1 Channel FX Mode Select Switch

Selects option for Channel FX SEND routing to; INT, EXT, or DUAL. For SEND to internal XONE:FX engine, external effects hardware connected via FX SEND / EXT RTN, or to both for simultaneous use with internal and external effects.

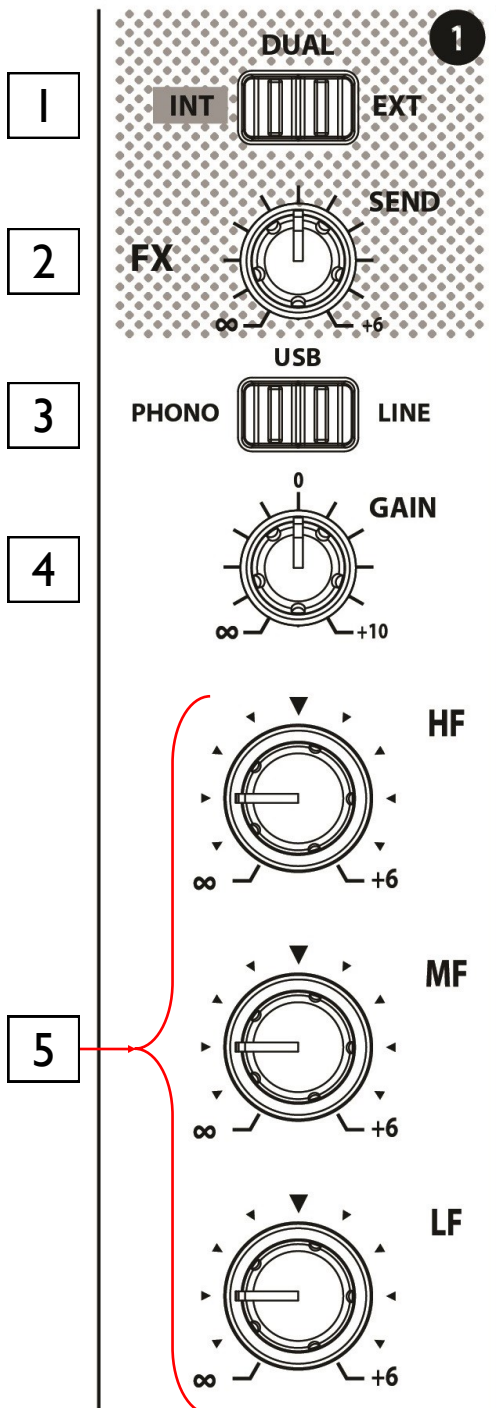

2 FX SEND Control

Controls the amount of Channel audio sent to the XONE:FX bus and/or external effects hardware connected via FX SEND / EXT RTN on the rear panel.

3 PHONO / USB / LINE Input Select Switch

Switch CH 1 - 4 inputs between RCA PHONO, CH 1 - 4 USB RTN soundcard inputs, or RCA LINE level audio sources.

4 Channel GAIN Control

Adjusts the Channel input sensitivity to compensate for different audio signal source levels. $-\infty/+10$ dB.

5 Channel Equalizer

Each main Channel is equipped with a powerful 3 band isolator EQ, providing a controlled +6dB boost when fully clockwise and full attenuation ('Total Kill') on each band when fully anti-clockwise.

Centre/cut-off frequencies are set at:

HF	3.5kHz	(High Frequency, <i>treble</i>)
MF	1.2kHz	(Mid Frequency)
LF	400Hz	(Low Frequency, <i>bass</i>)

PHONO / USB / LINE INPUT CHANNELS 1 - 4

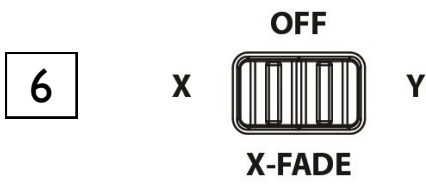

6 X-FADE Assign Switch
Use to assign the Channel to either X (left), or Y (right) side of the cross-fader, or direct to the MIX bus when OFF (centre),



7 Channel FILTER Select Switch
Press to route post-GAIN / post-EQ / post-FADER level Channel audio to the XONE:VCF. The switch illuminates BLUE when active.



8 Channel CUE Switch
Press to listen to the Channel pre-FADER audio levels from PHONES and BOOTH DJ monitor outputs and to view its level on the main (MIX) Meters. Press the switch again to deselect CUE.

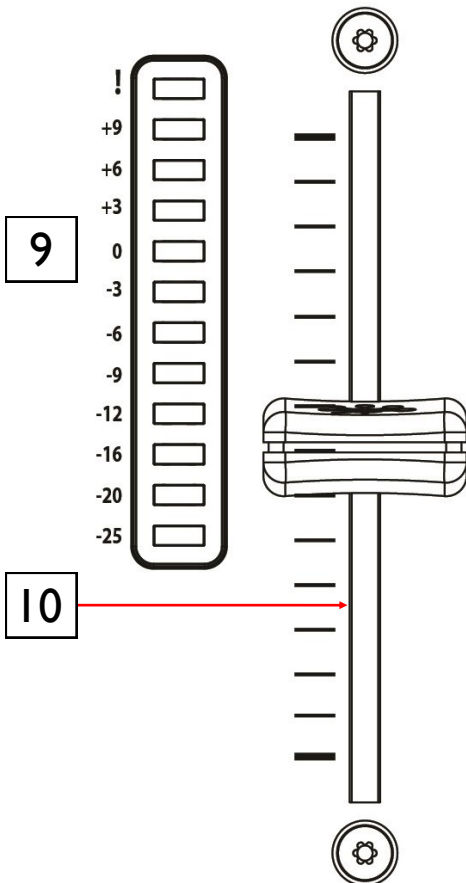

9 Channel Meter
Displays the channel signal level. Channel audio input is metered at post-GAIN / post-EQ and pre-FADER level, to display the affect of adjusting EQ on input levels before routing audio to the LR MIX. The channel GAIN control should be set so the meter averages about **0** with loudest peaks around **+6** and **+9**. If the ! indicator lights, turn the GAIN control *down*.

10 Channel Fader
A high quality, smooth travel, 60mm, dual-rail VCA fader adjusts the channel signal level from fully off to fully on.

CROSS-FADER

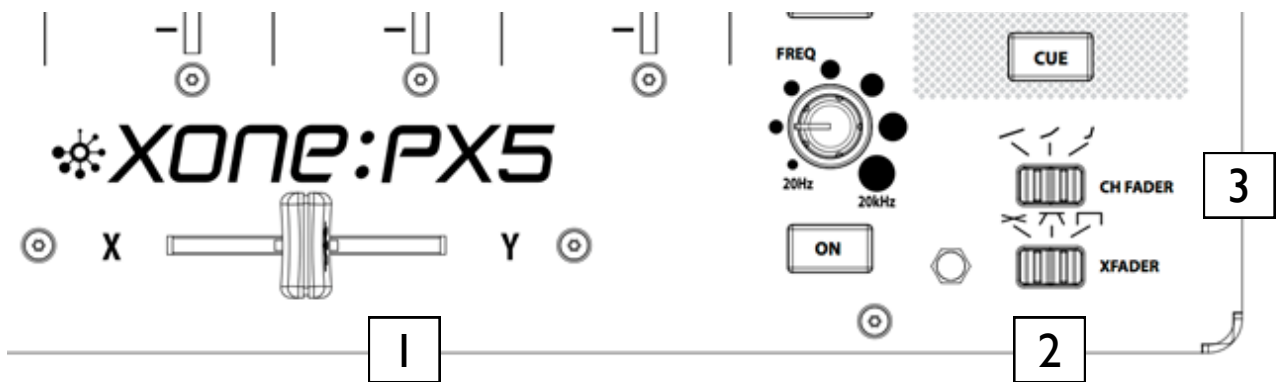

1 X-FADER

Fade between audio from CH 1 - 4 assigned to the X (Left), or Y (Right) side of the cross-fader, typically to fade smoothly into a new music track, to creatively layer sounds, or for scratch and cut mixing.

The cross-fader is a VCA (voltage controlled amplifier) control that also affects the level of signals routed via the XONE:VCF

Ensure switches on channels you want to fade are set to **X** or **Y** as appropriate.

When the XONE:FX, FX X-FADE switch is set to **X** or **Y**, the cross-fader acts as a VCA, controlling send levels to the internal XONE:FX engine, following the active FX:ASSIGN (see page 19) and X-FADER curve switch settings.

Assigned to **X**, the VCA send level is X = fully ON / Y = fully OFF.

Assigned to **Y**, the VCA send level is X = fully OFF / Y = fully ON.

2 XFADE Curve Control

This switch selects the cross-fader response curve between Constant power, Transition, or Fast-cut to suit scratch or cut mixing styles.

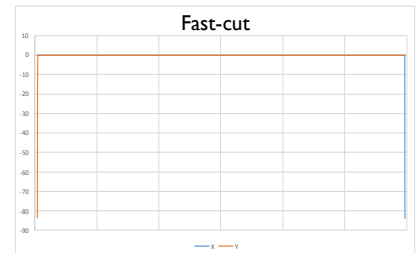
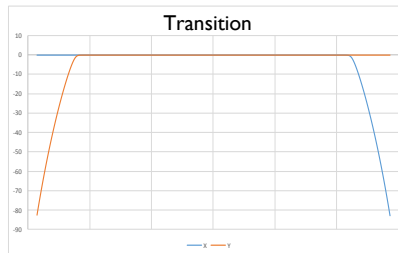
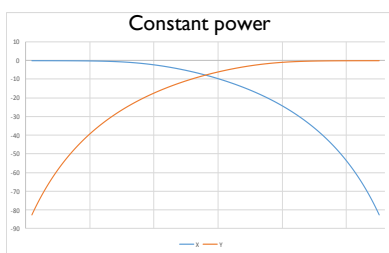

3 CH FADER Curve Control

This switch selects a global channel fader response curve for Stereo Input Channels 1 - 4 between Constant power, Dipped, or Fast-cut to suit scratch and cut mixing styles.

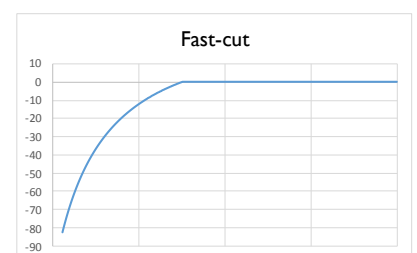
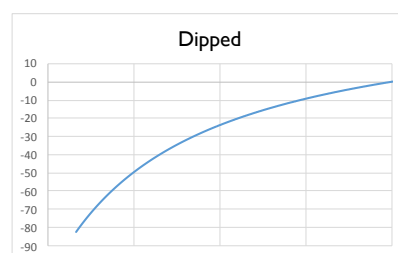
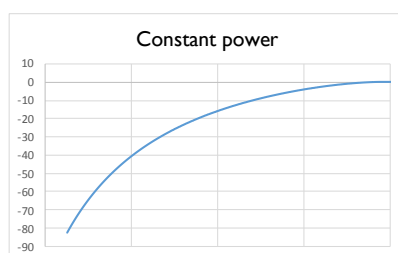

HEADPHONE SECTION

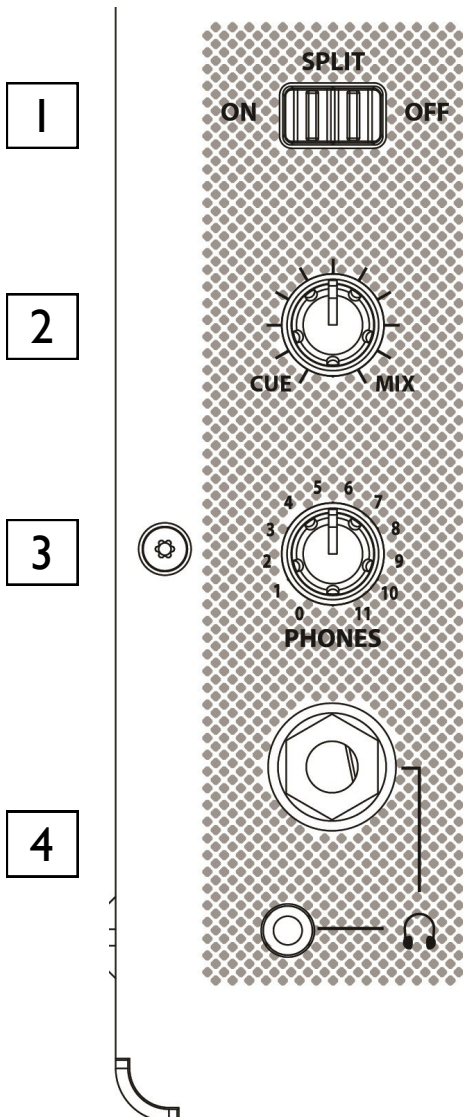

1 **SPLIT Cue Switch**

Selects the way the CUE bus operates.

Normally, pressing a Channel CUE switch overrides both left and right monitor program signals with the active CUE signal. With SPLIT set ON, the CUE bus overrides just the left channel, leaving the program in the right channel. L MIX meter displays CUE signal level and R MIX meter displays PRG (LR MIX level) signal. This is very useful when beat mixing using headphones.

2 **Cue / Mix Control**

Allows the main MIX output to be blended with the CUE signal. Turned fully anticlockwise, only active CUE Channels are heard through the headphones outputs. Gradually turning clockwise introduces the main MIX output to the headphones, together with active CUE.

Setting SPLIT, ON automatically overrides the control.

3 **PHONES Level Control**

Adjusts the level of the audio in the stereo headphones. This does not affect the level of the local booth monitor.

4 **Headphone Outputs**

Stereo 1/4" TRS jack and 3.5mm mini-jack sockets. Plug in good quality stereo headphones designed for DJ monitoring.

Use closed-ear headphones to provide maximum acoustic isolation when cueing your sources.

For more information, please refer to the **Operating Levels** section on page 47.

MASTER SECTION

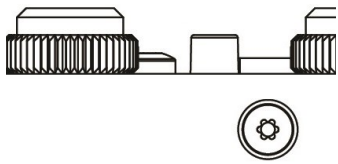

1

MASTER Level Control

A rotary MASTER control adjusts the level of the main, MASTER 1 and MASTER 2, rear panel outputs feeding the house sound system.

This does not affect BOOTH output level or the meters.

2

BOOTH Level Control

Adjusts the level of the signal to the stereo BOOTH RCA output. This does not affect the headphones level. BOOTH output can be used for a DJ Booth monitor, or as an additional zone feed or recording output.

3

MIX / Monitor Meters

The main meters follow the selected monitor source. The default display is the mix level, pre-master level, which is overridden with an input channel level if the channel cue switch is selected.

In SPLIT cue mode, the left (L) MIX meter displays the cued channel signal level and the right (R) MIX meter displays mix bus levels. Cued MIX audio level is pre-MASTER, to prevent mismatch due to position of the MASTER level control.

NOTE:

The mixer should be operated with meters averaging around **0** and loudest peaks between **+6** and **+9**.

If the **!** indicator lights, ensure **GAIN** or **EQ** settings are not clipping Channel meters and, if necessary, turn Channel **GAIN**, **EQ**, or **FADERS** down to prevent LR MIX meters clipping.

For more information, please refer to the **Operating Levels** section on page 47.

4

EXT RTN Level Control

Adjusts the level of audio input from effects hardware connected via FX SEND / EXT RTN and routed to the XONE:VCF or LR MIX outputs.

1



2

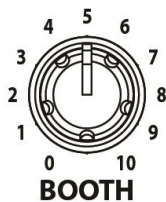

3

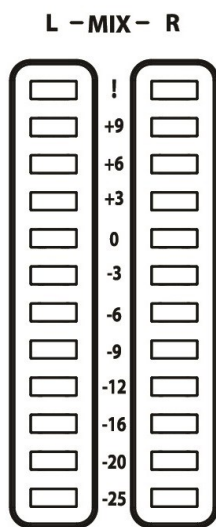

4

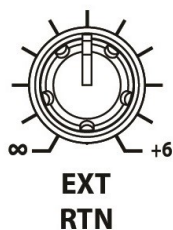

VOLTAGE CONTROLLED FILTER SECTION

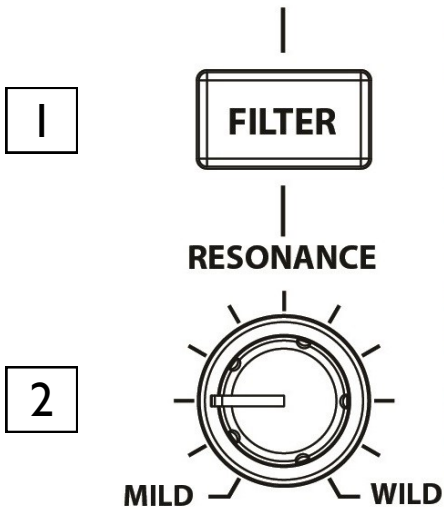

1 EXT RTN to FILTER Select Switch
 Press to route the EXT RTN input to the XONE:VCF, instead of directly into the main LR MIX, for extra versatility and creativity with your mixes.

2 RESONANCE Control
 This produces the classic Xone:VCF filter sound by feeding some of the filter output back to its input. The control ranges from MILD, producing a very subtle effect, to WILD, producing a dramatic phase effect with feedback just short of oscillation.



3 HPF Switch
 Turns on the High Pass Filter (bass cut) slope. See page 46 for more details.



4 BPF Switch
 Turns on the Band Pass Filter (bell shaped) slope. See page 46 for more details.



5 LPF Switch
 Turns on the Low Pass Filter (treble cut) slope. See page 46 for more details.

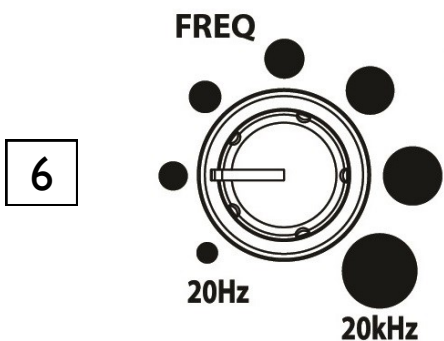

6 FREQ Frequency Sweep Control
 This control sets the -3dB cut-off frequency for the Voltage Controlled Filter. It ranges from very low frequency (20Hz) to very high frequency (20kHz).



7 XONE:VCF ON / OFF Switch
 Switches the Voltage Controlled Filter ON / OFF. Illuminates GREEN when active.

See the **Filter Reference** section on page 46 for more information.

XONE:FX CONTROL SECTION OVERVIEW

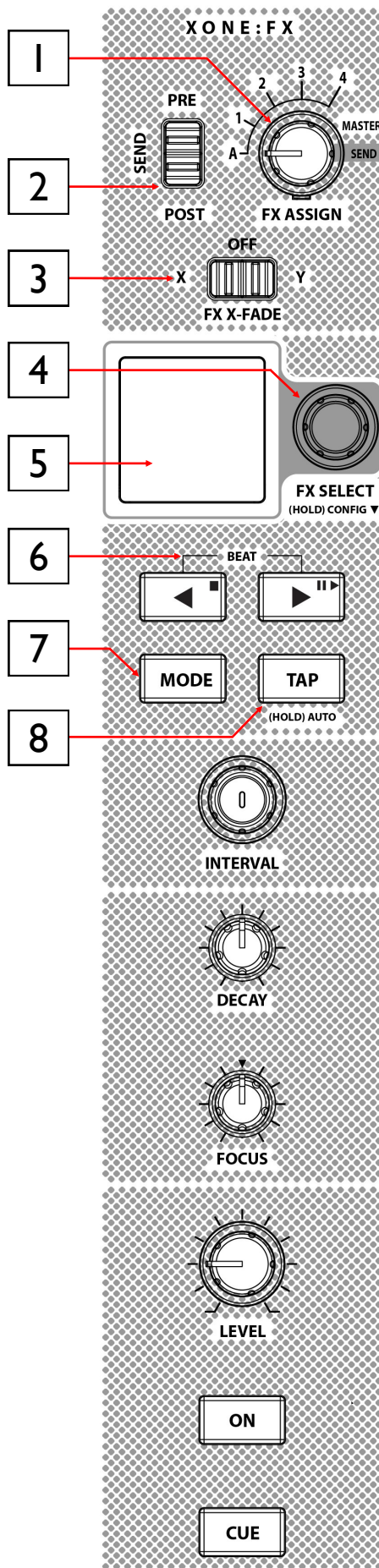

1 FX ASSIGN Switch

7 position rotary selector used to assign the internal XONE:FX engine routing as Channel INSERT (CH A, CH 1 - 4), Master INSERT, or SEND / RETURN to LR MIX.

Default position = SEND.

2 FX SEND PRE / POST Switch

Used to configure Internal and External FX SEND from Channels to pre-FADER, or post-FADER levels.

3 FX X-FADE Assign Switch

Assign the XONE:FX to X (left), or Y (right) position of the cross-fader to enable fading between Wet (effected) or Dry (un-effected) signal, or OFF (centre).

Default position = OFF

4 FX SELECT Encoder

Scroll between XONE:FX and CONFIG options. Push ONCE to enter FX MENU, Scroll then PRESS to select FX. Push + HOLD for CONFIG options.

5 TFT Screen

Displays XONE:FX types or current XONE:FX settings, BPM and MIDI CLOCK details, and other MENU options dependent on the active MODE.

6 BEAT Adjust / Tempo BEND / MIDI Transport

BEAT - Adjust beat fraction of any time based effect (Delay, Flanger, etc).

BEND - Press to speed up or slow down BPM Clock, or to lock-in sync.

MIDI - Transport sends START, STOP & CONTINUE messages for USB and MIDI SYNC / OUT.

7 MODE Button Switch

3 layer functionality. Push to increment and scroll through BEAT / BEND / MIDI CLOCK modes.

8 TAP Tempo Button

Guide the tempo of the BPM clock manually by tapping to the beat.

XONE:FX CONTROL SECTION continued

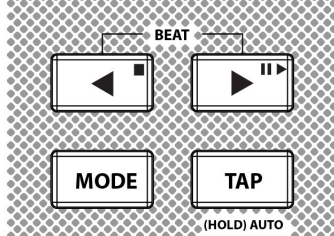
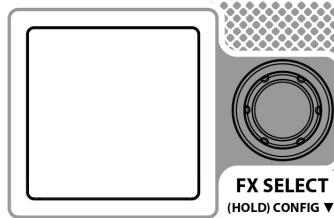
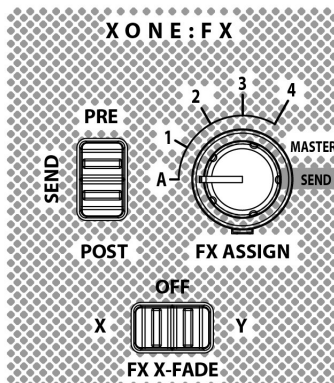

9 XONE:FX INTERVAL Control
 Rotary control to adjust beat fraction of the currently selected XONE:FX
 Illuminates WHITE when active
 The last adjustment setting is saved globally for FX recall

10 XONE:FX DECAY Control
 Rotary control to adjust time based parameters for the currently selected XONE:FX.
 Control illuminates RED
 The last adjustment setting is saved globally for FX recall
 Default position = MIN (fully anti-clockwise).

11 XONE:FX FOCUS Control
 Rotary control with centre detent used to adjust tonal parameters for the currently selected XONE:FX.
 Turning anti-clockwise = LPF. Turning clockwise = HPF
 Control illuminates RED or BLUE when active
 Control illuminates GREEN in centre (OFF) position
 Default position = centre (OFF).



12 XONE:FX LEVEL Control
 Adjust XONE:FX output level to LR MIX in SEND mode.
 Blend level between Channel audio and selected XONE:FX in INSERT mode.
 Illuminates RED when SND / RTN is active.
 Illuminates CYAN when INSERT is active.

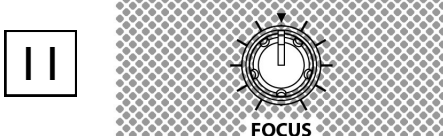
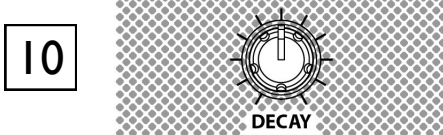

13 XONE:FX ON Switch
 Turns the internal XONE:FX channel ON / OFF.
 Illuminates GREEN when active.

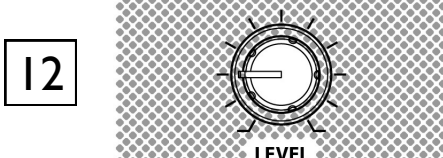

14 XONE:FX CUE Switch
 Press to listen to the FX channel pre-Fade signal level from PHONES outputs and to view its level on the main LR MIX meters.
 Illuminates RED when active.



XONE:XCITE FX LIBRARY REFERENCE

NAME	FX1 PROGRAM	FX2 PROGRAM	BEAT	INTERVAL	DECAY	FOCUS
MASIF-Q DELAY	Stereo Beat Delay (Pre Delay Filters)		Time Fraction	Time MS	Delay Regen	Delay Output Filters
PCM DELAY	Stereo Beat Delay (Pre Delay Filters)	Compressor	Time Fraction	Time MS	Delay Regen	Delay Input Filters
FILTER DELAY	Stereo Beat Delay (Post Delay Filters)	Compressor	Time Fraction	Time MS	Delay Regen	Delay Output Filters
DLY & RVB	Stereo Beat Delay	Hall Reverb	Time Fraction	Time MS	Delay Regen	Reverb Filters
MOD DELAY	Bucket Brigade Delay	Mod Doubler	Time Fraction	Time MS	Delay Regen	Mod LFO Speed
TAPE ECHO	Space Echo			Echo Repeat Rate	Echo Intensity	Echo Tone
CLEAN PLATE	Plate Reverb			Reverb Diffusion Level	Reverb Decay Time	Reverb Filters
SWELL VERB	EMT Reverb	Compressor		Reverb Diffusion Level	Reverb Decay Time	Reverb Filters
CONCRT HALL	Plate Reverb			Reverb Diffusion Level	Reverb Decay Time	Reverb Filters
TILED ROOM	Room Reverb			Reverb Diffusion Level	Reverb Decay Time	Reverb Filters
ATTACK GATE	Stereo Beat Delay	Gated Reverb	Time Fraction	Time MS	Gated Reverb Attack Time	Gated Reverb Filters
RESO GATE	Stereo Beat Delay	Gated Resonator	Time Fraction	Time MS	Gated Resonator Release Time	Gated Resonator Frequency
FLANGER	Mod Flanger	Compressor	Time Fraction	Time MS	Mod Resonance	Mod Depth
PITCH VERB	Vocal Shifter	Plate Reverb		Reverb HF Slope	Reverb Decay time	Vocal Shifter Semitones
TIME WARP	Vocal Shifter	Stereo Beat Delay	Time Fraction	Time MS	FX2 > FX1 Feedback Level	Vocal Shifter Semitones
DISTORTION	Clipper					Distortion Amount

BPM DETECTION

The Xone:PX5 features an internal BPM engine that is used for synchronising the internal XONE:FX to the incoming audio signal.

It is also used for transmitting or receiving midi clock information through the Xone:Sync engine.

BPM Detection

By default the Xone:PX5 BPM detection is Automatic (**AUTO**) between 60 - 260 BPM and continuously listens to the FX source:

When in FX INSERT for channels **1, 2, 3, 4, or A**, the BPM source is derived from the Assigned Channel.

When FX ASSIGN is set to: **SEND** or **MASTER**, the XONE:FX BPM is derived from the main LR MIX Clean-feed (Pre XONE:FX Return).

Hold **TAP** for 3 seconds to reset BPM detection back to **AUTO**

MIDI Clock Transmit

The Xone:PX5 can generate internal MIDI clock signals which can be sent via USB to a DAW, or via the MIDI SYNC / OUT port to external hardware.

Refer to the MIDI SETUP Menu option on page 23 for details.

When MIDI Clock Transmit is **OFF** BPM Detection is Automatic (AUTO)

When MIDI Clock is **ON** FX unit BPM is derived from the Master MIDI Clock.

MIDI Clock BPM can be adjusted from the menu on the screen or by the 'BEND' layer on the top panel buttons < >

Tap Tempo will overwrite Master MIDI Clock BPM

BPM Clock range 60.00 – 260.00

BPM Accurate to: 000.00 - 2 decimal places

MIDI Clock Receive

If your playback source is a DAW or DJ software running through the internal Hi-Speed USB multi-channel soundcard, you can use MIDI clock as the timing source for the Xone:PX5; this will override normal BPM detection and affects all channels.

If you select this mode ensure that your DAW supports sending MIDI clocks, and that this feature is enabled.

When MIDI Clock is set to **OFF** BPM Detection is Automatic as above (**BPM Detection**).

When MIDI Clock is set to **Receive** FX unit is derived from the incoming external MIDI Clock .

XONE:SYNC

The Xone:PX5 features Xone:Sync which enables you to synchronise external equipment through the USB connection and the MIDI SYNC / OUT port.

Xone:Sync can generate internal MIDI clock signals which can be sent via USB to a DAW or via the MIDI SYNC / OUT port to external hardware devices, such as drum machines, synths or external effects processors.

It can also receive MIDI clock signals via USB from a DAW or DJ performance software which will ensure that the XONE:FX engine is synchronised accurately to the incoming audio signal.

Sending External MIDI Clock via USB

Connect the Xone:PX5 directly to your laptop using a type A-B USB cable.

Ensure that your DAW is set-up to receive MIDI clock (consult the manufacturer's documentation to find out how to do this).

In AUTO BPM detection mode, the Xone:PX5's internal BPM engine will set the BPM based on the incoming audio signal of the channel selected by the FX ASSIGN control.

In this example, the AUTO BPM engine will detect the BPM from the input signal of Channel 2.

This will be used as the tempo of the MIDI clock output via USB to your DAW.

To control the playback

Press the MODE button to enter the GREEN layer.

This mode controls the MIDI Clock transport controls; STOP / START / PAUSE

To send the Xone:PX5's internal MIDI Clock to your DAW, press the PLAY button.

So long as your DAW is set to receive MIDI Clock correctly, this will start playback in the software.

Pressing the STOP button will **stop** playback.

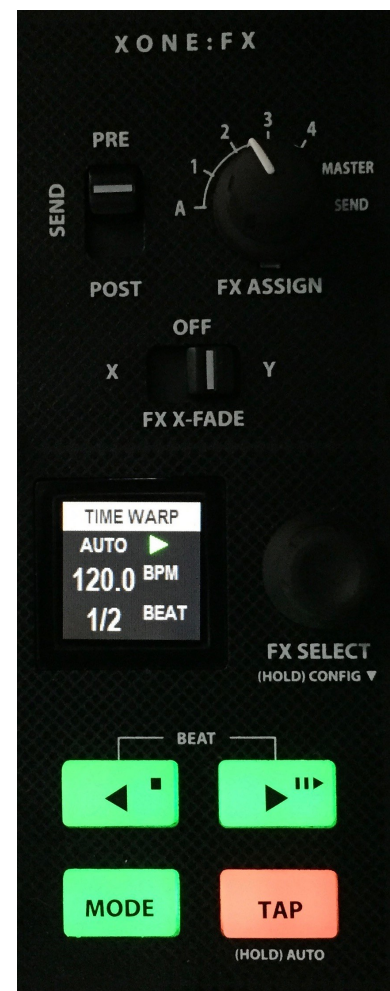

Sending External MIDI Clock via MIDI SYNC / OUT

Connect the Xone:PX5 to your external device using a 5pin DIN MIDI cable.

Ensure that your DAW is set-up to receive MIDI clock.

Consult your software application documentation to find out how to do this.

Follow the steps above to control the playback of your external device.

XONE:SYNC continued

Adjusting the Xone:Sync DIN offset

When sending external MIDI Clock via the MIDI SYNC / OUT port, you can offset the signal in order to time-align the synchronisation of external hardware devices, which compensates for the inherent latency when syncing external devices.

1



To access the DIN offset control, hold down the FX SELECT control to enter the CONFIG menu..

Use the FX SELECT control to scroll down to highlight DIN OFFSET. Press FX SELECT to enter the DIN OFFSET setup.



FX SELECT

2



Press the FX SELECT control. The parameter will be highlighted in RED.

Use the FX SELECT control to adjust the DIN OFFSET time in MS. You can adjust the time by up to +/- 50ms.



FX SELECT

3



Press FX SELECT, then scroll to highlight EXIT. Press again to return to the main CONFIG menu.

Use the FX SELECT control to scroll down to highlight EXIT and press to leave the CONFIG menu.

Continue to adjust the DIN offset until your external device is in sync with the Xone:PX5 BPM engine.



FX SELECT

NOTE: It is not possible to adjust the MIDI Clock offset via USB when synchronising external software. This is achieved through the software MIDI preferences.

Please refer to your software application documentation for details how to do this.

MIDI Clock Tempo Bend

When sending external MIDI Clock via the USB or the MIDI SYNC / OUT port, you can bend the tempo to momentarily speed up or slow down the MIDI Clock signal in order to time-align the synchronisation of external software and hardware devices.

To access the MIDI Clock Tempo Bend controls, press the MODE button to access the BLUE layer.

By holding down either the TEMPO BEND DOWN button (<) or the TEMPO BEND UP button (>), you can momentarily speed up or slow down the MIDI Clock output, much like beat matching, in order to time-align the phase of the external software or hardware.

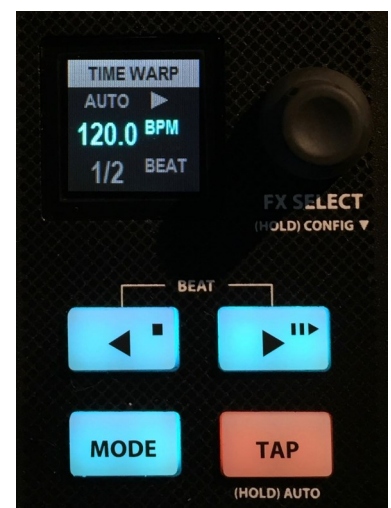

XONE:SYNC continued

Receiving MIDI Clock via USB from an external DAW or DJ performance software

The Xone:PX5 can be configured to receive MIDI Clock from an external DAW or DJ performance software via the USB connection. Connect the Xone:PX5 directly to your computer using a type A-B USB cable.

1



Hold down the FX SELECT control to enter the CONFIG menu, and scroll to select **CLOCK**.



FX SELECT

2

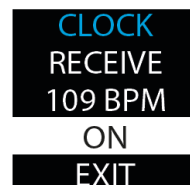

Push down on the FX SELECT control to enter the CLOCK menu.

Scroll and press the FX SELECT control to turn MIDI CLOCK RECEIVE **ON / OFF**



FX SELECT

3

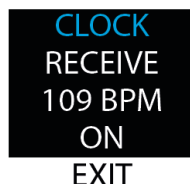

Scroll down using the FX SELECT control and press FX SELECT to exit. Exit the CONFIG menu.

The display will now show MIDI RX indicating that the Xone:PX5 is in EXTERNAL MIDI CLOCK RECEIVE MODE.



FX SELECT

Ensure that your software is set-up to transmit MIDI Clock to the Xone:PX5.

Please consult your software application documentation for details on how to do this.

Now, when you start your external DAW, the Xone:PX5 BPM engine will follow the tempo set in the DAW, and the XONE:FX engine will be in sync.

DRIVER INSTALLATION (PC)

Installing XONE:PX5 Soundcard Device Drivers

Apple Mac OS X

The Xone:PX5 is a Mac CoreAudio and CoreMIDI class compliant interface and works on Apple Mac platforms without hardware device drivers.

Microsoft Windows® PC

In order to access the soundcard channels on your Xone:PX5 you will need to install the dedicated Device Drivers, which can be downloaded from the Allen & Heath website:

www.allen-heath.com/xonepx5

PLEASE FOLLOW INSTALL INSTRUCTIONS CAREFULLY

NOTE: Please ensure you are logged on to the PC with Administrator access enabled.

When the driver package has downloaded, extract the installer to your computer desktop.

Follow the on-screen instructions as detailed below:

The installer will also prompt you through the steps necessary to install this software.

- Double-click on the **Xone:PX5 DriverSetup** file to begin.

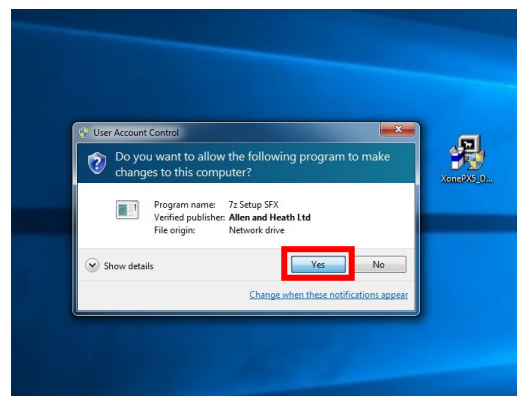
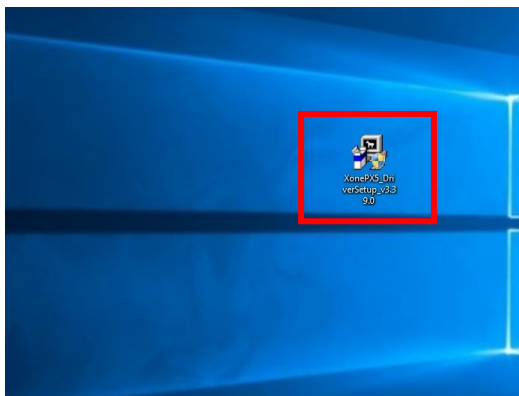

- Click **Yes** on the User Account Control prompt to confirm and continue installation.

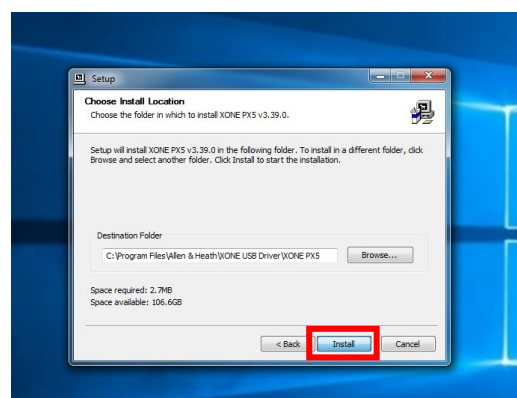
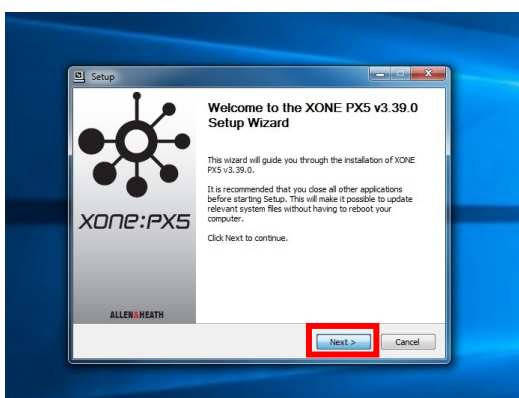

- Click **Next** to run the installer application.
- Click on the **Install** tab to pre-install the Device Drivers to the default system folder.

A series of messages will be displayed...

DRIVER INSTALLATION (PC) continued

- This may take some time to complete.
- Please wait while XONE:PX5 v3.39.0 software is installed...

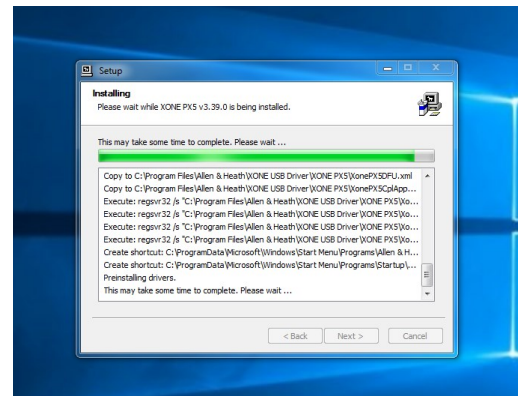
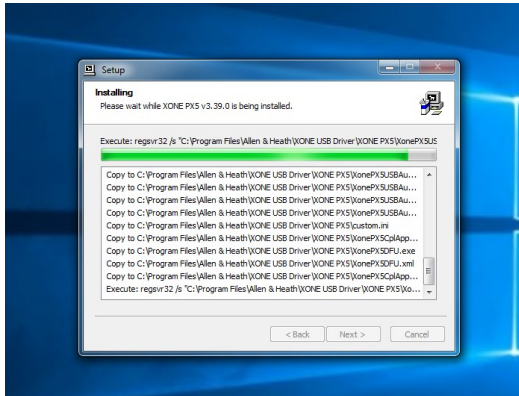

- Click **Install** when prompted to install Allen&Heath Sound, video and game controllers software.

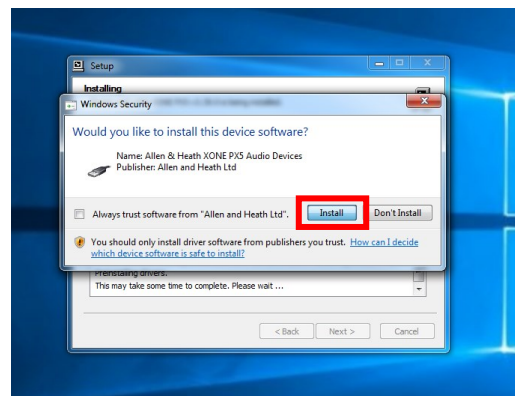
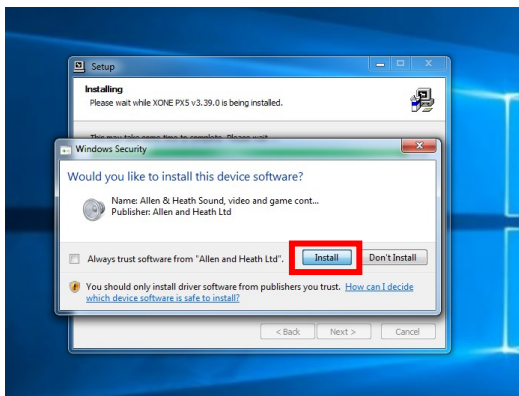

- Click **Install** when prompted to install Allen&Heath XONE:PX5 Audio Devices software.
- Connect the Xone:PX5 DJ Mixer to your PC via USB and power the unit **ON**.

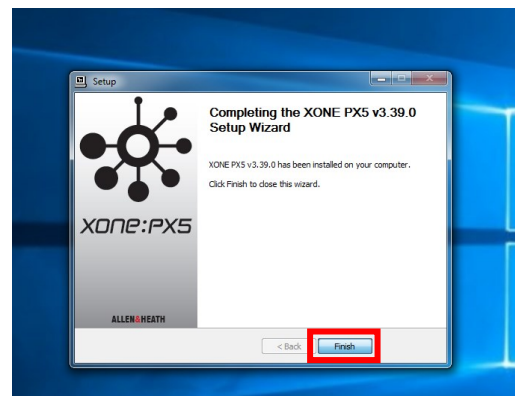
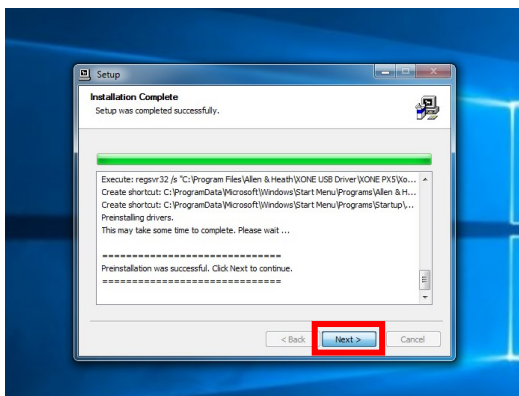

- Click **Next** to continue once the pre-installation process has completed.
- Click **Finish** to complete the Device Driver installation.

NOTE:

It is possible to complete the Xone:PX5 Device Driver pre-installation process without connecting the Xone:PX5 mixer to your computer. In this case you are prompted to “...disconnect and reconnect the device to complete driver installation.”

If the mixer cannot be connected, click **Yes** on the prompt to close the application.

To complete installation, connect the Xone:PX5 to your PC via USB, power the mixer **ON**.

Wait for PC to enumerate the mixer before opening your DAW software application.

USB SOUND CARD — DEFAULT

The Xone:PX5 includes a 20 Channel (5 Stereo IN / 5 Stereo OUT), 24Bit/96kHz, Hi-Speed USB internal soundcard.

Mac USB Class Compliant CoreAudio CoreMIDI interface;

No Driver installation is required for operation with Mac OS X.

For operation with Microsoft Windows® PC, see the **Driver Installation** section on page 26.

USB Soundcard Specification

Channels: 20 Channel (5 Stereo IN / 5 Stereo OUT),
 Supported Variable Buffer Sizes: 32 / 64 / 128 / 256 / 512 / 1024 / 2048 / 4096 / 8192 samples
 Supported Sample Rates: 44.1 kHz / 48kHz / 88.2kHz / 96kHz
 Bit depth: 24Bit
 USB MIDI Ports: 1 x MIDI IN / 1 x MIDI OUT

DEFAULT USB AUDIO ROUTING		
Mixer Channel to Computer		
Soundcard Input	Xone:PX5	DAW Software IP Option
USB_1	CH1 L (RIAA or LINE)_SND_L_1	Analogue 1
USB_2	CH1 R (RIAA or LINE)_SND_R_1	Analogue 2
USB_3	CH2 L (RIAA or LINE)_SND_L_2	Analogue 3
USB_4	CH2 R (RIAA or LINE)_SND_R_2	Analogue 4
USB_5	CH3 L (RIAA or LINE)_SND_L_3	Analogue 5
USB_6	CH3 R (RIAA or LINE)_SND_R_3	Analogue 6
USB_7	CH4 L (RIAA or LINE)_SND_L_4	Analogue 7
USB_8	CH4 R (RIAA or LINE)_SND_R_4	Analogue 8
USB_9	MASTER L or FXSEND_L_A	Analogue 9
USB_10	MASTER R or FXSEND_R_A	Analogue 10
Mixer Channel from Computer		
Soundcard Output	Xone:PX5	DAW Software OP Option
USB_1	CH 1 L (USB)_RTN_L_1	Analogue 1
USB_2	CH 1 R (USB)_RTN_R_1	Analogue 2
USB_3	CH 2 L (USB)_RTN_L_2	Analogue 3
USB_4	CH 2 R (USB)_RTN_R_2	Analogue 4
USB_5	CH 3 L (USB)_RTN_L_3	Analogue 5
USB_6	CH 3 R (USB)_RTN_R_3	Analogue 6
USB_7	CH 4 L (USB)_RTN_L_4	Analogue 7
USB_8	CH 4 R (USB)_RTN_R_4	Analogue 8
USB_9	CH 5 L (USB)_RTN_L_A	Analogue 9
USB_10	CH 5 R (USB)_RTN_R_A	Analogue 10

NOTE: The Xone:PX5 is fully Traktor Scratch Certified for use with timecode control setups from Traktor Scratch Pro 2 v2.11

Please refer to page 37 for details on configuring the Xone:PX5 for Traktor Scratch Pro 2.

MIDI CONTROL

MIDI stands for Musical Instrument Digital Interface; an interface protocol from the 1980s to enable different keyboards, sequencers, drum machines, etc. to communicate with each other. MIDI is still a common interface used by most DAW software to allow remote control of various functions within the program.

The Xone:PX5 has the ability to send and receive MIDI and features a total of 51 MIDI enabled controls;

39 buttons/switches, 5 Faders and 7 rotary controls, that can be assigned to enable control of various parameters in DJ performance software, or DAW (Digital Audio Workstation) applications.

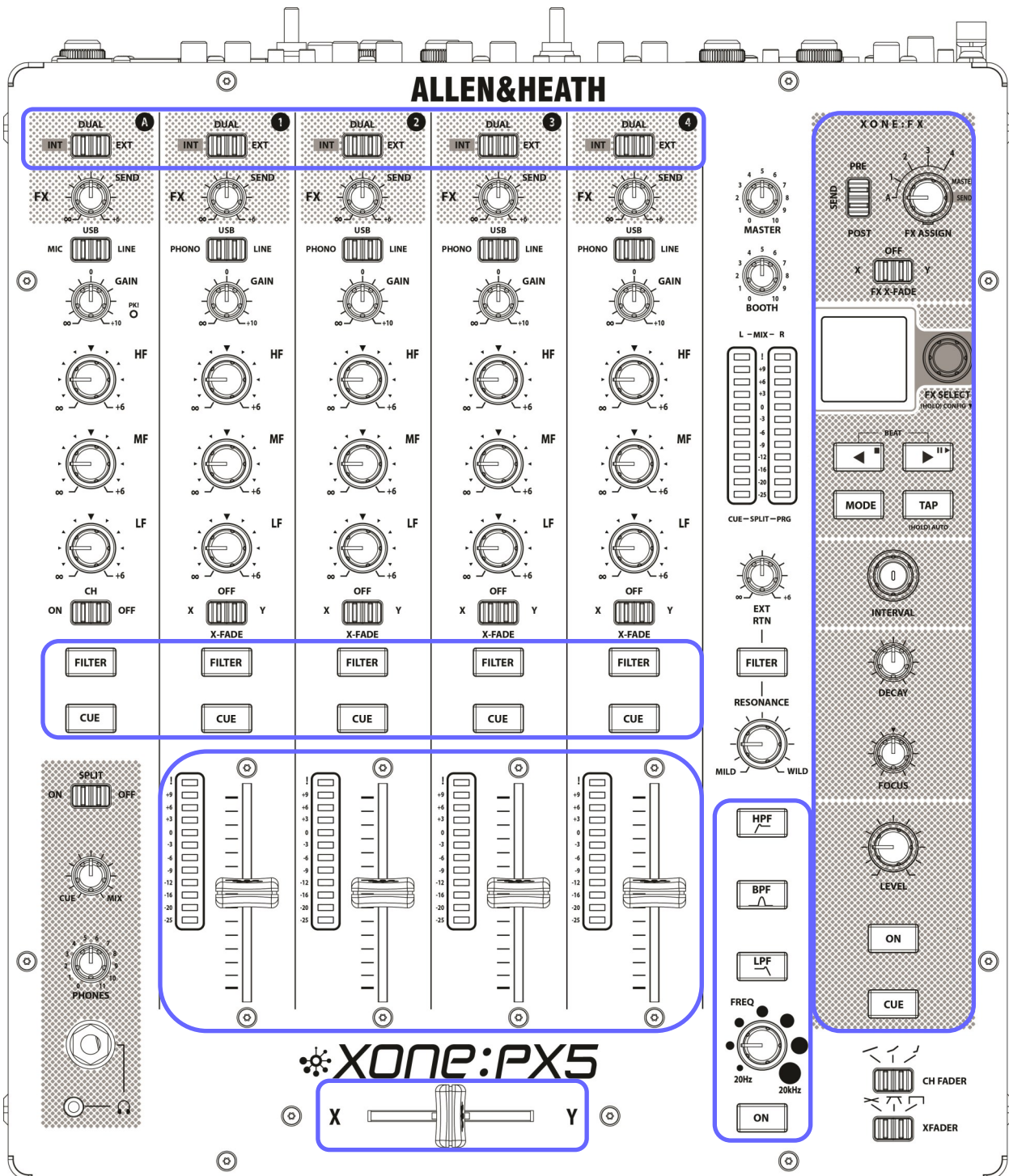

MIDI CONTROL continued

CHANNEL FX MODE SELECT SWITCHES

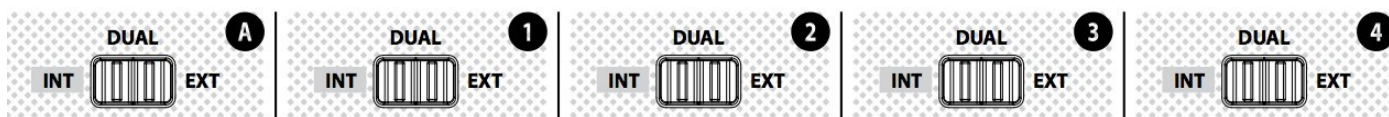

XONE:PX5 CHANNEL	FX MODE		
	INT	DUAL	EXT
A	C-2	OFF	C#-2
	CH16	< >	CH16
1	D-2	OFF	D#-2
	CH16	< >	CH16
2	E-2	OFF	F-2
	CH16	< >	CH16
3	F#-2	OFF	G-2
	CH16	< >	CH16
4	G#-2	OFF	A-2
	CH16	< >	CH16

CHANNEL FILTER SELECT SWITCHES



XONE:PX5 CHANNEL	FILTER
A	A#-2
	CH16
1	B-2
	CH16
2	C-1
	CH16
3	C#-1
	CH16
4	D-1
	CH16
EXT RTN	D#-1
	CH16

MIDI CONTROL continued

CHANNEL CUE SELECT SWITCHES

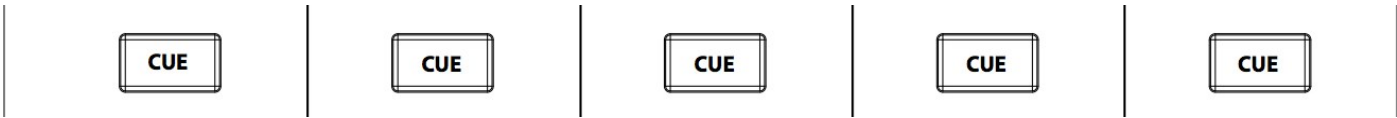

XONE:PX5 CHANNEL	CUE
A	E-I
	CHI6
1	F-I
	CHI6
2	F#-I
	CHI6
3	G-I
	CHI6
4	G#-I
	CHI6
XONE:FX	DI
	CHI6

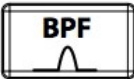

XONE FILTER

FILTER	HPF	BPF	LPF	FREQ	ON
	A-I	A#-I	B-I	CC5	C0
	CHI6	CHI6	CHI6	CHI6	CHI6

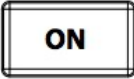
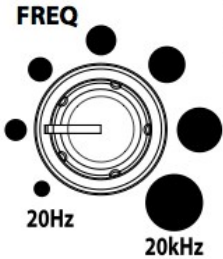
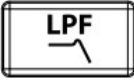

MIDI CONTROL continued

XONE:FX

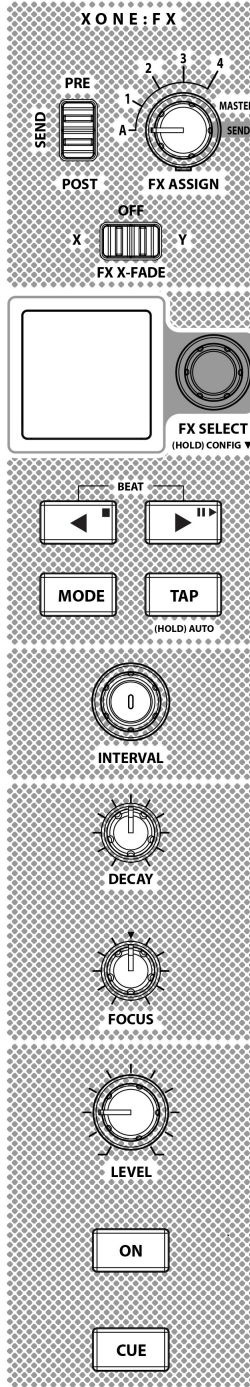

XONE:FX	PRE/ POST	MODE	TAP	ON	CUE	FX X-FADE		
						X	OFF	Y
	C#0	B0	CI	C#1	DI	D0	OFF	D#0
CHI6	CHI6	CHI6	CHI6	CHI6	CHI6	<>	CHI6	

XONE:FX	ASSIGN	SELECT	INTERVAL	DECAY	FOCUS	LEVEL
	CC6	CC7	CC8	CC9	CC10	CC11
	CHI6	CHI6	CHI6	CHI6	CHI6	CHI6

MIDI CONTROL continued

XONE:SYNC

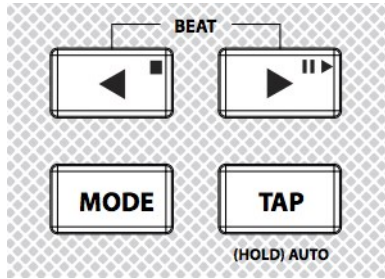

XONE:SYNC	BEAT LEFT	BEAT RIGHT	BEND LEFT	BEND RIGHT	STOP	PLAY
	F0	F#0	G0	G#0	A0	A#0
	CHI6	CHI6	CHI6	CHI6	CHI6	CHI6

FADERS

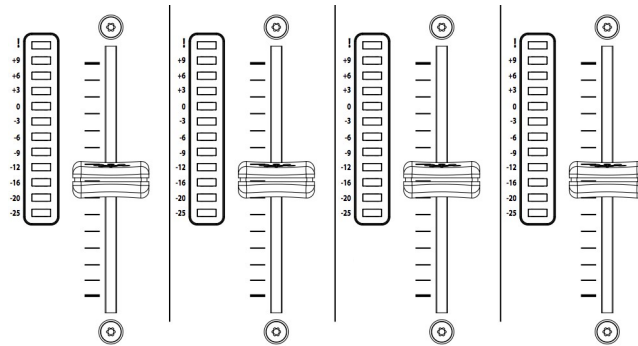

XONE:PX5

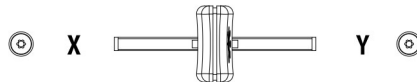

XONE:PX5 CHANNEL	FADER
1	CC0
	CHI6
2	CC1
	CHI6
3	CC2
	CHI6
4	CC3
	CHI6
X-FADER	CC4
	CHI6

MIDI CHANNEL CHANGE

1



FX SELECT

The Xone:PX5 DJ Mixer default MIDI Channel is 16.

You can change MIDI channel by holding down the FX SELECT control to enter the CONFIG menu.

2



FX SELECT

Select CHANNEL and press the FX SELECT control.

This will display the current MIDI Channel.

Press the FX SELECT control to highlight current MIDI Channel.

Rotate the FX SELECT control to change the MIDI Channel.

3



FX SELECT

Press FX SELECT to confirm the new MIDI Channel selection.

4



FX SELECT

Rotate the FX SELECT control to scroll down to EXIT.

Press the FX SELECT control to exit the CHANNEL menu.

5



FX SELECT

Rotate the FX SELECT control to scroll down to EXIT.

Press the FX SELECT control to exit the CONFIG menu.

NOTE:

MIDI Channel will remain set to the last user selected channel when power to the mixer is switched OFF.

If no change has been made in the CONFIG menu, the mixer powers ON set to default MIDI Channel 16.

MIDI NOTE IMPLEMENTATION TABLE

Octave	Note Numbers																							
	C		C# / Db		D		D# / Eb		E		F		F# / Gb		G		G# / Ab		A		A# / Bb		B	
-1	0	0	1	1	2	2	3	3	4	4	5	5	6	6	7	7	8	8	9	9	10	0A	11	0B
0	12	0C	13	0D	14	0E	15	0F	16	10	17	11	18	12	19	13	20	14	21	15	22	16	23	17
1	24	18	25	19	26	1A	27	1B	28	1C	29	1D	30	1E	31	1F	32	20	33	21	34	22	35	23
2	36	24	37	25	38	26	39	27	40	28	41	29	42	2A	43	2B	44	2C	45	2D	46	2E	47	2F
3	48	30	49	31	50	32	51	33	52	34	53	35	54	36	55	37	56	38	57	39	58	3A	59	3B
4	60	3C	61	3D	62	3E	63	3F	64	40	65	41	66	42	67	43	68	44	69	45	70	46	71	47
5	72	48	73	49	74	4A	75	4B	76	4C	77	4D	78	4E	79	4F	80	50	81	51	82	52	83	53
6	84	54	85	55	86	56	87	57	88	58	89	59	90	5A	91	5B	92	5C	93	5D	94	5E	95	5F
7	96	60	97	61	98	62	99	63	100	64	101	65	102	66	103	67	104	68	105	69	106	6A	107	6B
8	108	6C	109	6D	110	6E	111	6F	112	70	113	71	114	72	115	73	116	74	117	75	118	76	119	77
9	120	78	121	79	122	7A	123	7B	124	7C	125	7D	126	7E	127	7F								
	DEC	HEX	DEC	HEX	DEC	HEX	DEC	HEX	DEC	HEX	DEC	HEX	DEC	HEX	DEC	HEX	DEC	HEX	DEC	HEX	DEC	HEX	DEC	HEX

CC	Hex	Note
0	0x00	C-1
1	0x01	C#-1
2	0x02	D-1
3	0x03	D#-1
4	0x04	E-1
5	0x05	F-1
6	0x06	F#-1
7	0x07	G-1
8	0x08	G#-1
9	0x09	A-1
10	0x0A	A#-1
11	0x0B	B-1
12	0x0C	C0
13	0x0C	C#0
14	0x0D	D0
15	0x0E	D#0
16	0x10	E0
17	0x11	F0
18	0x12	F#0
19	0x13	G0
20	0x14	G#0
21	0x15	A0

CONNECTING X:LINK CONTROLLERS

Connecting XONE:K Series Controllers

The Xone:PX5 includes X:LINK, enabling remote control over computer software programs via a direct connection between the mixer and Xone:K Series MIDI Controllers.

X:LINK uses a standard RJ-45 connector to distribute power and MIDI data, avoiding the need to use additional computer USB ports, or a USB hub.

Connect the Cat-5 Ethernet (RJ-45) patch lead, supplied with your Xone:K Series controller, to the X:LINK OUT socket of the controller.

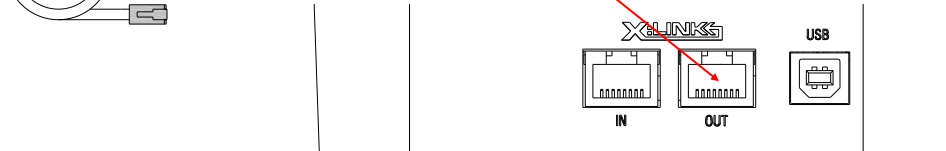

Connect the other end of the patch lead to the X:LINK socket on the rear panel of the Xone:PX5

NOTE:

Ensure the Xone:K Series unit is configured to send and receive MIDI messages via a different channel to the Xone:PX5

For example:

Xone:PX5 = CH16
Xone:K = CH15

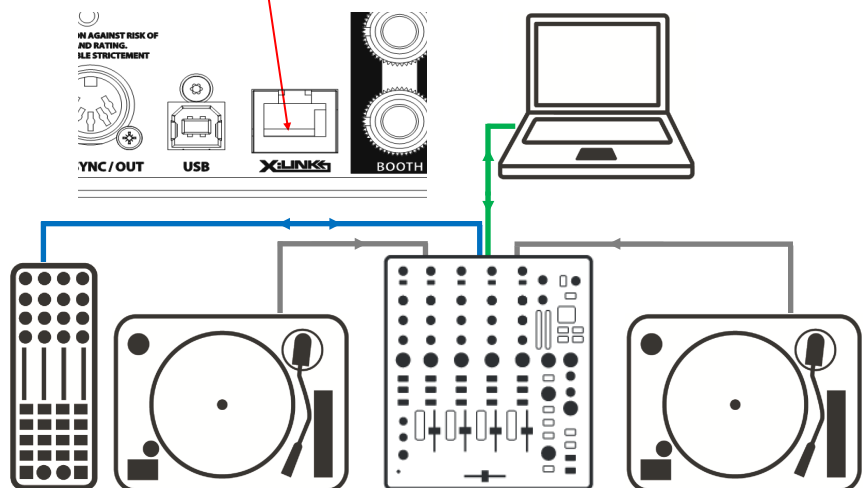

It is also possible to further expand remote MIDI control over software by 'daisy-chaining' two Xone:K Series controllers, using another Cat-5 Ethernet (RJ-45) patch lead between X:LINK OUT on the second Xone:K Series unit and X:LINK IN on the controller connecting to the X:LINK socket on the Xone:PX5 rear panel.

NOTE:

Ensure both Xone:K Series units and the Xone:PX5 are configured to send and receive MIDI messages on different channels.

For example:

Xone:PX5 = CH16
1st Xone:K = CH15
2nd Xone:K = CH14

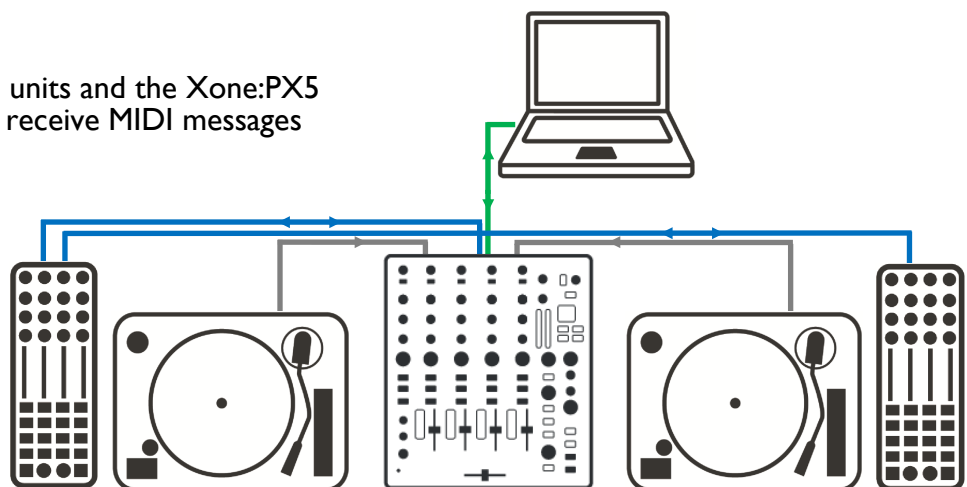

Using setups described above, set Xone:PX5 as the MIDI device in the host software preferences.

Please refer to your software application documentation for details on how to do this.

TIMECODE SETUP - TRAKTOR SCRATCH PRO 2

This section explains how to set up TRAKTOR SCRATCH PRO 2 to control playback via Timecode from an external turntable or CD player when using with a Xone:PX5 DJ Mixer.

- Ensure TRAKTOR SCRATCH PRO 2 is installed and activated on your computer
NOTE: TRAKTOR PRO 2 does not support Timecode control.
- Ensure that your Xone:PX5 DJ Mixer is connected to the computer via USB.
- Connect turntables or CDJ media players to the LINE / PHONO Inputs on the Xone:PX5.
- Set the USB LN / PH switches on the Xone:PX5 rear panel for turntables or CDJ media players.
E.g. Switch *in* to PH for use turntables. Switch *out* to LN for use with CDJ media players.



- Next, on the Xone:PX5 top panel;
- set the corresponding Channel PHONO / USB / LINE Switch to: USB.



- Next, in TRAKTOR SCRATCH PRO 2; open **Preferences**
- Select the **Audio Setup** dialogue
- Check, or Select **Xone:XP5** as the **Audio Device**.

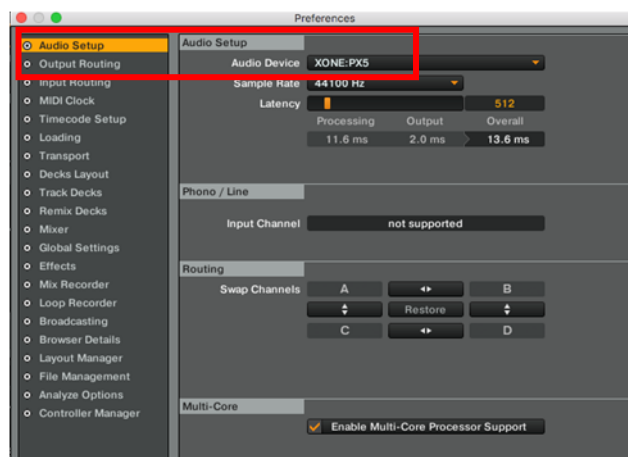

TIMECODE SETUP continued

- Next, select the **Output Routing** dialogue
- Check, or select **Mixing Mode > External**.
- When connected, the Xone:PX5 internal soundcard *input* channels 1 - 8 default to; TRAKTOR Deck Layout: **C-A-B-D**



- Next, select the **Input Routing** dialogue
- When connected, Xone:PX5 internal soundcard *output* channels 1 - 8 default to; TRAKTOR Deck Layout: **C-A-B-D**

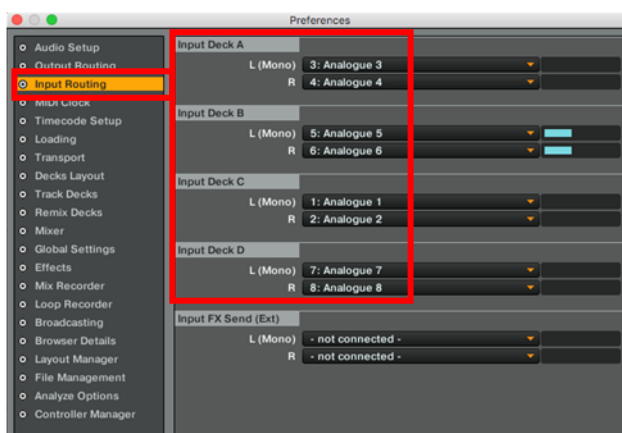

TIMECODE SETUP continued

- Select the **Timecode Setup** dialogue
- Change the **Timecode inputs** on the decks (A/B/C/D) from; Internal Playback to **Scratch Control**



- Select the **Decks Layout** dialogue
- In the section **Platter / Scope**, choose **Scope** for the Decks you want to control with timecode.

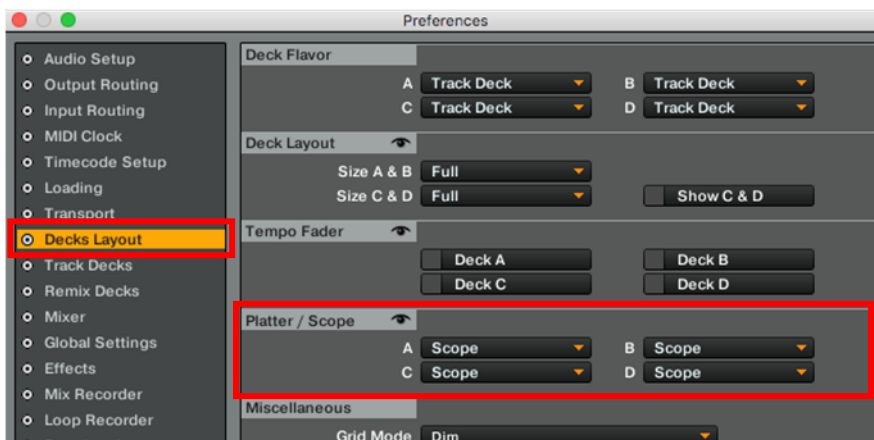

- **Calibrate** the deck(s) on the scopes with the timecode source; Control CD, Control Vinyl, or WAV on a USB stick.



RECORDING A MIX - TRAKTOR SCRATCH PRO 2

- On the Xone:PX5 rear panel, set the **USB 9-10 MST/FX** switch to: **MST**.



- In Traktor, select the **Input Routing** dialogue.
- Set **Input FX Send (Ext)** to: **L (Mono) 9: Analogue 9 / R 10: Analogue 10**



- Next, select the **Mix Recorder** dialogue.
- Set **Source** to: **External**.
- Set **External Input** to; **Input FX Send (Ext)**.

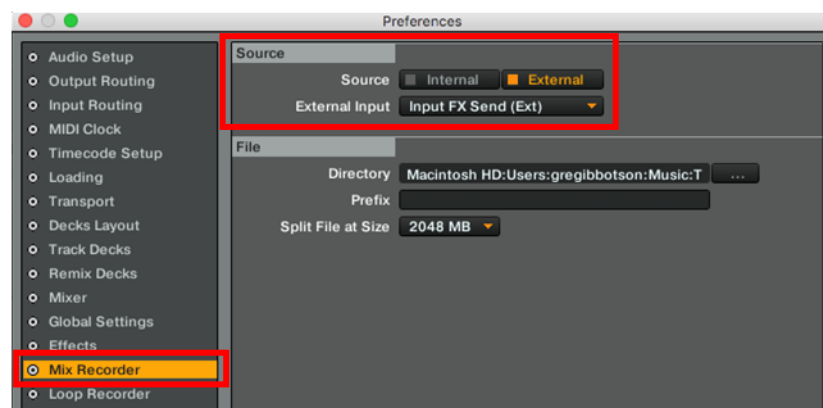

- Finally, go to the **Audio Recorder** in the main Traktor screen, set your level and hit record.

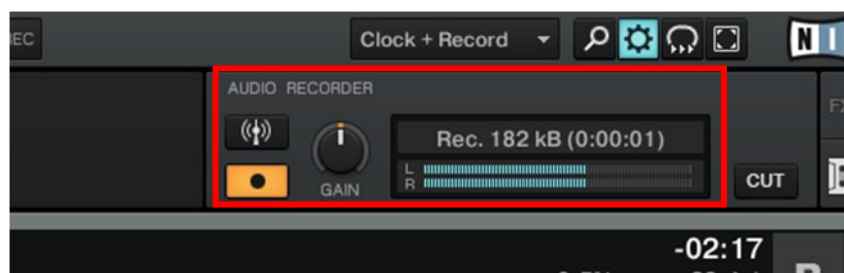

BLOCK DIAGRAM

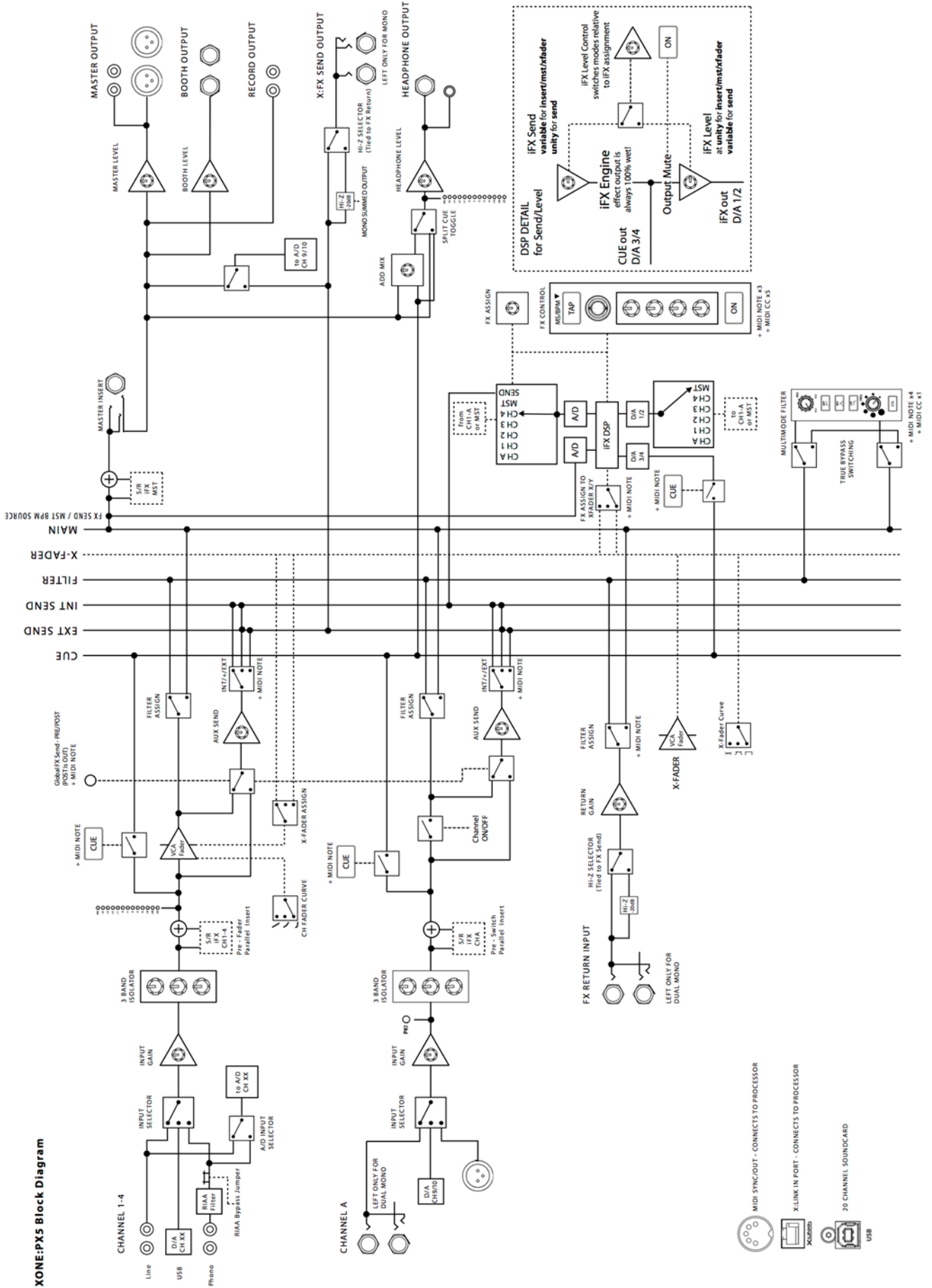

XONE:PX5 Block Diagram

SPECIFICATIONS

Hardware Specification

Output Levels; Nom / Max	Master Mix	+ 4dBu	+24dBu
	Master RCA	-10dBV	+ 8dBV
	Booth	0dBu	+18dBu
	FX Send	0dBu	+18dBu
	Record RCA	-10dBV	+ 8dBV
Internal headroom	Channels	+18dB	
Frequency response	Line in to master out	+/-0.5dB from 20Hz to 30kHz	
Distortion	Typically 0.01% @ 1kHz 0dBu		
Crosstalk	< -85dB inter-channel @ 1kHz +10dBu		
Residual Noise	Master Mix	-96dBu	
	Master RCA	-99dBu	
	Booth	-96dBu	
Mix Noise	Master Mix	-86dBu	
	Master RCA	-95dBu	
	Booth	-90dBu	
	Record RCA	-95dBu	
Mic Gain	+40dB, EIN = -118dB (@ 40dB gain with 150R source)		
RIAA Gain	+39dB @ 1kHz	(10mV RMS= 0VU @ 1kHz)	
Channel/ Master Meters	12 LED	-25dBu to +12dBu	
Channel EQ	LF 400Hz MF 1.2kHz HF 3.5kHz +6dB boost to 'Total Kill'. Total Kill attenuation -75dB		
Channel fader	60mm VCA control individually replaceable. Plug in replacement - user replaceable (see p.44) < -85dB shutoff @ 1kHz +10dBu		
Cross-fader	45mm Voltage Controlled Amplifier control. Plug in replacement - user replaceable (see p.44)		
Filters	Stereo. Analogue Voltage Controlled Filter.		

Digital Architecture Specification

Analogue/Digital conversion	24 bit
Analogue/Digital Line-up	+14dBu = 0dBFS
USB soundcard sampling frequency range	44.1kHz to 96kHz

SPECIFICATIONS continued

Model	Xone:PX5
Type	Analog
Channels	4 + 1
EQ	3-band / Total Kill (CH 1- 4 + CH A)
USB Soundcard	20 Channel (10 in / 10 out) USB2 / Class Compliant 24bit / 96kHz 1 x MIDI IN 1 x MIDI Out
Line Inputs	4 x RCA (CH 1- 4) 1 x 1/4" TRS (CH A) Mono/Stereo
Phono Inputs	4 x RCA (CH 1- 4) LN/PH Switch for DVS
USB Inputs	5 x USB (CH 1- 4 + CH A)
Mic Input	1 x XLR
Master Output	1 x XLR (Balanced)
Master 2 Output	1 x RCA (Un-balanced)
Booth Output	1 x 1/4" TRS
Record Output	1 x RCA (Un-balanced)
Master Insert	1 x 1/4" TRS
MIDI Sync/Out	1 x 5-Pin DIN DIN Offset Control
Send/Return I/O	1 x 1/4" TRS Send 1 x 1/4" TRS Return 1 x LN/Hi-Z Switch
Internal Xone:FX	Yes
Hybrid FX Mode	Yes (Internal < Dual > External)
FX Send	1 x Pre/Post Selectable (CH 1- 4 + CH A)
Filter	1 x Voltage Controlled Filter HPF / BPF / LPF Adjustable Frequency & Resonance Assignable CH 1- 4 + CH A + External Return
X-Link	1 x RJ45
Headphones	1 x 1/4" 1 x 3.5mm Split Cue Monitoring
Channel Faders	60mm Voltage Controlled Amplifier / Replaceable
Chanel Meters	12 Segment LED
Channel Fader Curve	3 Types
X-Fader	45mm VCA / Replaceable / innoFADER Pro2 Compatible
X-Fader Curve Settings	3 Types
MIDI Clock	Send + Receive Start / Stop / Pause / Tempo Bend (-/+)
MIDI Assignable	Yes (MIDI CC / MIDI Note ON -OFF)
BPM Detection	Auto / Manual / Tap Tempo
Earth Ground Terminals	x 2
Headroom	+20dB
AC Mains	100 to 240V AC 50/60Hz Consumption 35W max
Mains Adaptor	3 pin IEC socket with cable clamp
Fuse Rating	250V AC TIAL 20mm

PANEL DRAWINGS / WEIGHTS & DIMENSIONS

XONE:PX5	UN-PACKED		PACKED	
Height	110mm	4.3"	190mm	7.5"
Width	320mm	12.6"	450mm	17.7"
Depth	375.6mm	14.8"	530mm	20.9"
Weight	5.2kg	11.5lbs	6.6kg	14.6lbs

Top Panel View

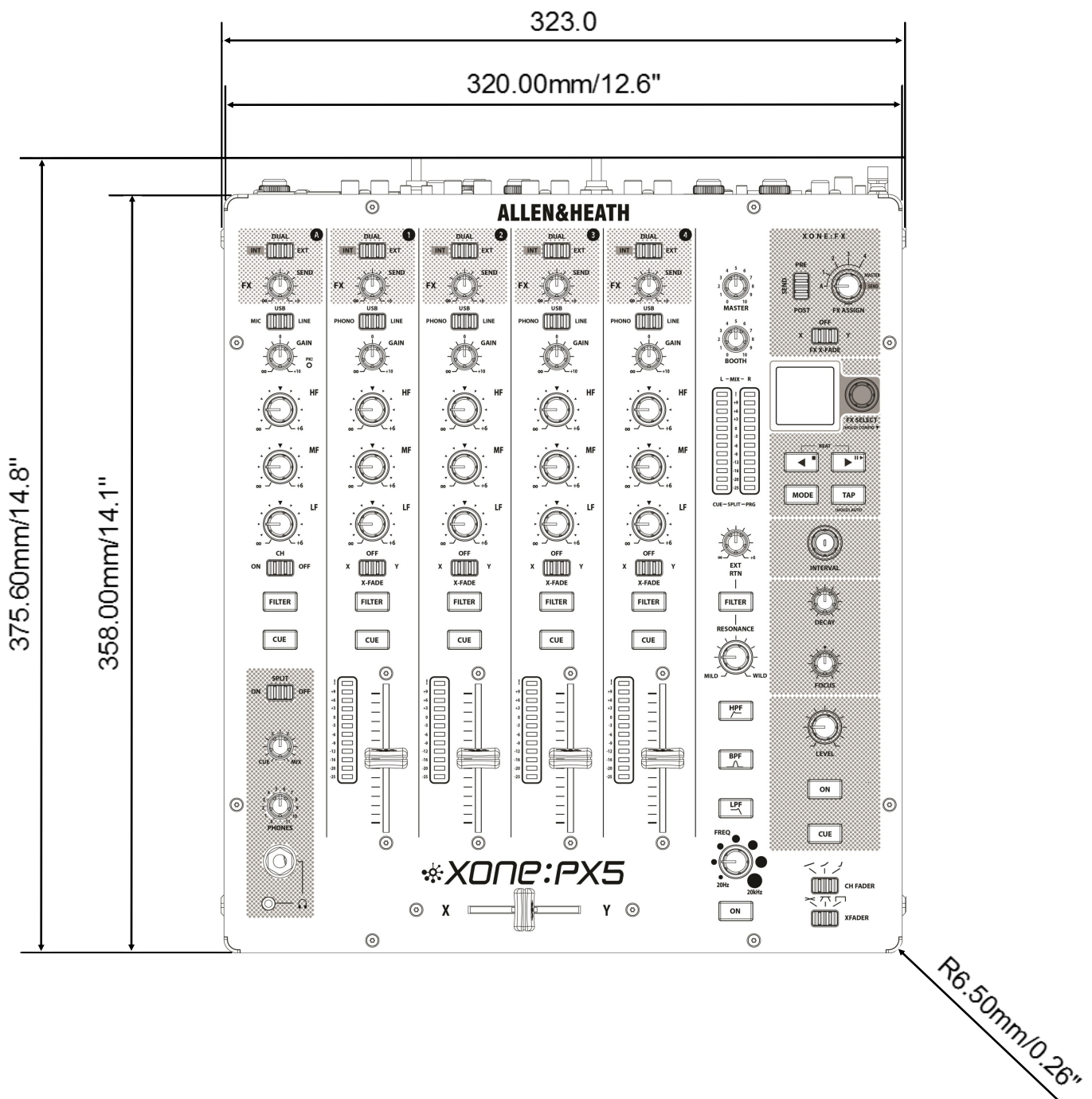

PANEL DRAWINGS continued

Rear Panel View

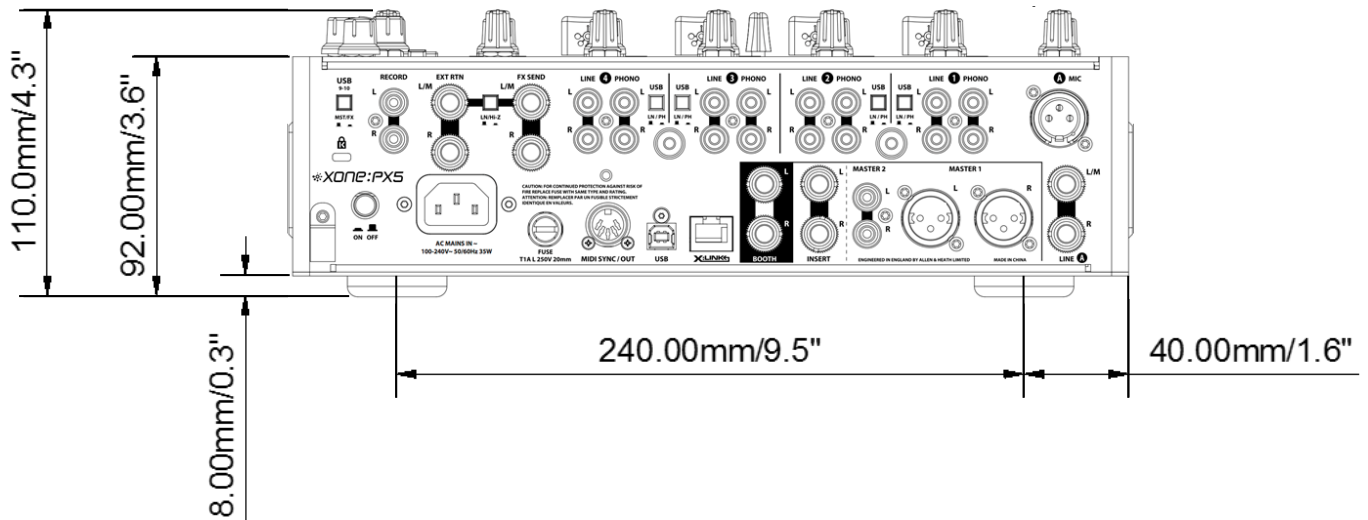

IMPORTANT NOTE: Warning ! Do NOT cover louvres on Front or Side Panels !
 Xone:PX5 is **NOT** compatible with standard Xone Series Rack Ear kits.

Side View

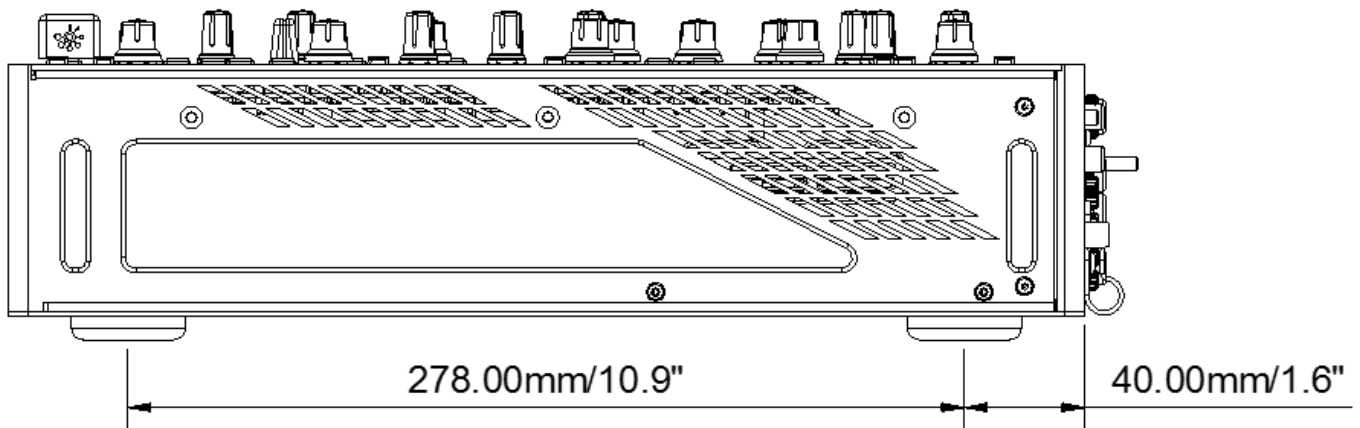

Front View

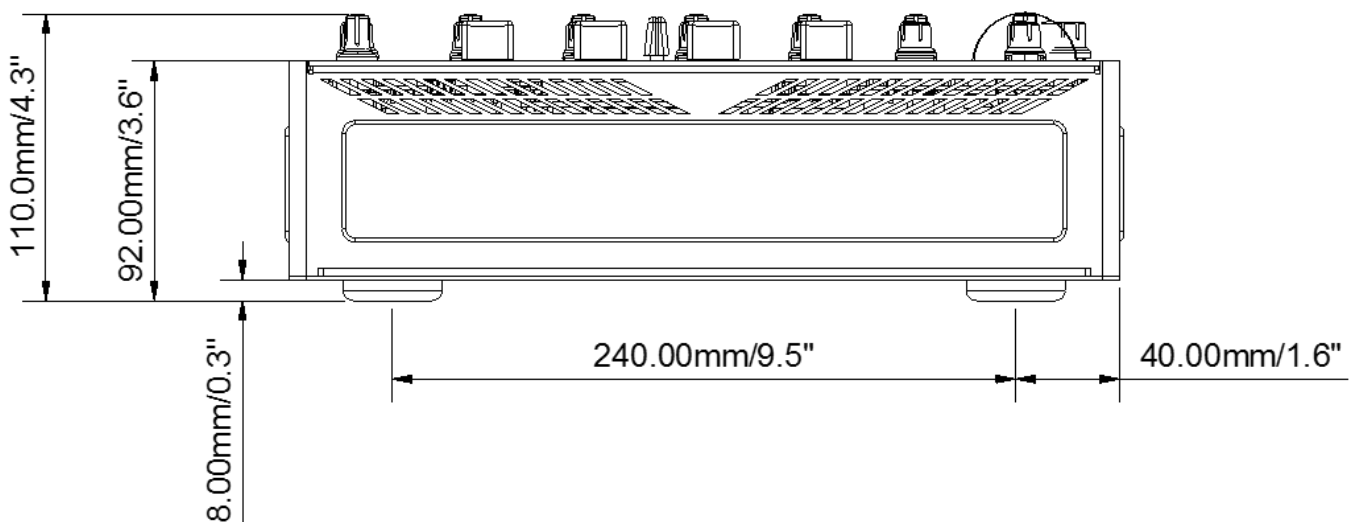

FILTER REFERENCE

The XONE:VCF Voltage Controlled Filter

A Voltage Controlled Filter is an audio filter where the cut-off frequency is altered by a DC control voltage rather than a variable resistor. This produces a much wider operating range and more control over the filter response to create unlimited combinations of tonal effect.

Filter Type Select

The filters are 'state variable'. This means that they provide three simultaneous filter types: high-pass, band-pass and low-pass. Three large illuminated switches select which type is active. You can press any combination together to create different response types such as 'notch' and an interesting 'all-pass' effect. The switches are 'soft switched' for live performance, meaning that the audio signal is ramped between filter states to prevent audible clicks.

NOTE: the last selected XONE:VCF response and Channel FILTER assignments are saved when mains power to the mixer is turned OFF.

The graphs below show typical effects on audio frequency response for the three filter types. The range of sweep from low to high frequency is shown together with the effect of adjusting RESONANCE (one frequency with several resonance settings shown). The vertical scale shows the amount of cut or boost around the normal 0dB operating level. The horizontal scale shows the change in frequency from low (bass) to high (treble).

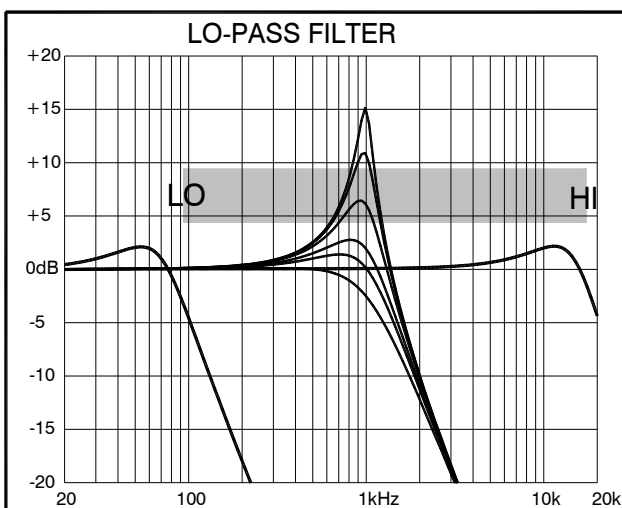
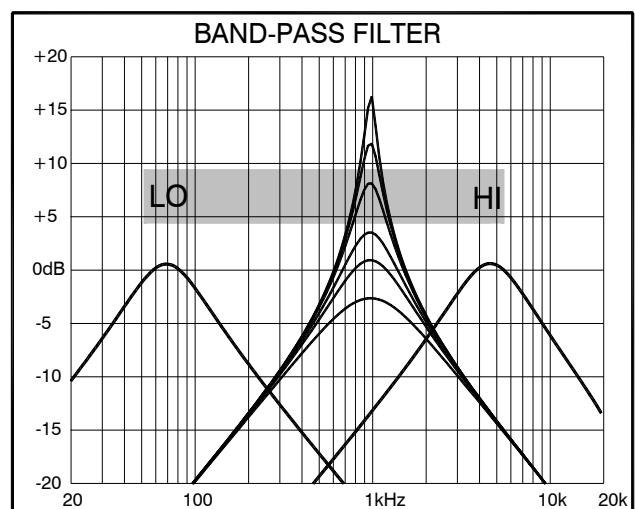
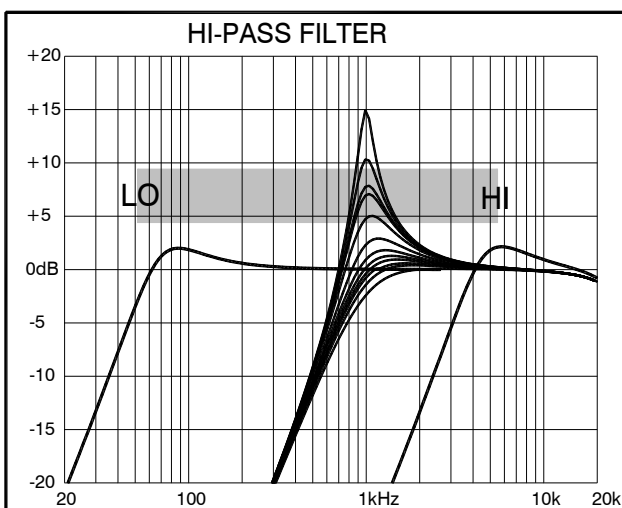

OPERATING LEVELS

It is most important that the system level settings are correctly set. It is well known that many DJs push the level to maximum with meters peaking hard in the belief that they are getting the best from the system. **THIS IS NOT THE CASE !**

The best can only be achieved if the system levels are set within the normal operating range and not allowed to peak.

Peaking simply results in signal distortion, not more volume. It is the specification of the amplifier / speaker system that sets the maximum volume that can be achieved, not the console.

The human ear too can fool the operator into believing that more volume is needed. Be careful as this is in fact a warning that hearing damage will result if high listening levels are maintained.

Remember that it is the **QUALITY** of the sound that pleases the ear, not the **VOLUME**.

The diagram below illustrates the operating range of the audio signal.

NORMAL OPERATING RANGE. For normal music the signal should range between -6 and $+6$ on the meters with average around 0 dB. This allows enough **HEADROOM** for unexpected peaks before the signal hits its maximum **CLIPPING** voltage and distorts.

It also achieves the best **SIGNAL-TO-NOISE-RATIO** by keeping the signal well above the residual **NOISE FLOOR** (system hiss).

The **DYNAMIC RANGE** is the maximum signal swing available between the residual noise floor and clipping.

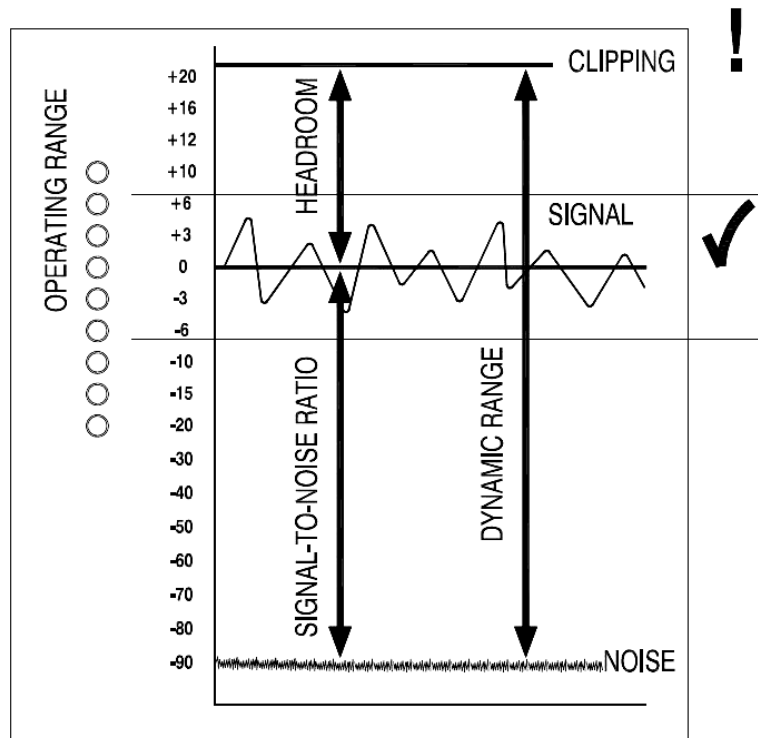

An important note ...

The human ear is a remarkable organ with the ability to compress or 'shut down' when sound levels become too high.

Do not interpret this natural response as a reason to turn the system volume up further !

As the session wears on ear fatigue may set in, and the speaker cones may become hot so reducing the effectiveness of the system and listeners to gain any benefit from increased volume.

EARTHING

The connection to earth (ground) in an audio system is important for two reasons:



SAFETY - To protect the operator from high voltage electric shock, and

AUDIO PERFORMANCE - To minimise the effect of earth (ground) loops which result in audible hum and buzz, and to shield the audio signals from interference.

For safety it is important that all equipment earths are connected to mains earth so that exposed metal parts are prevented from carrying high voltage which can injure or even kill the operator. It is recommended that a qualified system engineer check the continuity of the safety earth from all points in the system including microphone bodies, turntable chassis, equipment cases, and so on.

The same earth is also used to shield audio cables from external interference such as the hum fields associated with power transformers, lighting dimmer buzz, and computer radiation. Problems arise when the signal sees more than one path to mains earth. An 'earth loop' (ground loop) results causing current to flow between the different earth paths. This condition is usually detected as a mains frequency audible hum or buzz.

To ensure safe and trouble-free operation we recommend the following:

Have your mains system checked by a qualified electrician. If the supply earthing is solid to start with you are less likely to experience problems.

Do not remove the earth connection from the console mains plug. The console chassis is connected to mains earth through the power cable to ensure your safety. Audio 0V is connected to the console chassis internally. If problems are encountered with earth loops operate the audio 'ground lift' switches on connected equipment accordingly, or disconnect the cable screens at one end, usually at the destination.

Make sure that turntables are correctly earthed. A chassis earth terminal is provided on the console rear panel to connect to turntable earth straps.

Use low impedance sources such as microphones and line level equipment rated at 200 ohms or less to reduce susceptibility to interference. The console outputs are designed to operate at very low impedance to minimise interference problems.

Use balanced connections for microphones and mix output as these provide further immunity by cancelling out interference that may be picked up on long cable runs. To connect an unbalanced source to a balanced console input, link the cold input (XLR pin 3 or jack ring) to 0V earth (XLR pin 1 or jack sleeve) at the console. To connect a balanced XLR output to unbalanced equipment, link the cold output to 0V earth at the console.

Use good quality cables and connectors and check for correct wiring and reliable solder joints. Allow sufficient cable loop to prevent damage through stretching.

If you are not sure ...

Contact your service agent or local Allen & Heath dealer for advice.

REPLACING THE FADERS

Channel and cross-faders subject to excessive 'wear and tear', or extensive use, over time will require replacing. Intermittent or noisy operation is an indication of faders becoming worn. Using a proprietary fader cleaner, such as CaigLube, DeOxit, etc. may temporarily restore use, but **DO NOT** use on new faders as this can displace factory applied finishes.

IMPORTANT NOTES:

Warning! Please read the following steps *in full* **BEFORE** starting work.

If you are unsure of your ability to safely carry out the procedure described, it is advised that you contact an authorised Allen & Heath agent for local service assistance by a qualified technician. Please contact your mixer retailer, or local authorised Allen & Heath agent, for more information:

www.allen-heath.com/where-to-buy

Ensure that the power switch on the rear panel is set OFF and that IEC mains cable is disconnected from the AC mains supply **BEFORE** opening the unit.

Have a clean flat work surface ready before starting work.

Tools you will need:

- T8 Torx screwdriver 
- Pliers
- A small container for retaining screws

Ensure erroneous objects, such as cover screws etc. do not fall into the chassis or through louvres during disassembly, and check to make sure none are loose inside the unit **BEFORE** reassembling.

To replace Faders

ONLY use spare part components approved by Allen & Heath for replacement.

Please contact your mixer retailer, officially authorised Allen & Heath spares supplier, or local authorised Allen & Heath agent to order spare A&H parts: www.allen-heath.com/where-to-buy

To replace the factory standard Allen & Heath Alpha Channel Fader, order;

A&H spare part-code: **004-852X - XONE:PX5 CH FDR SPARE**



To replace the factory standard Allen & Heath Alpha cross-fader, order;

A&H spare part-code: **004-853X - XONE:PX5 XFDR SPARE**

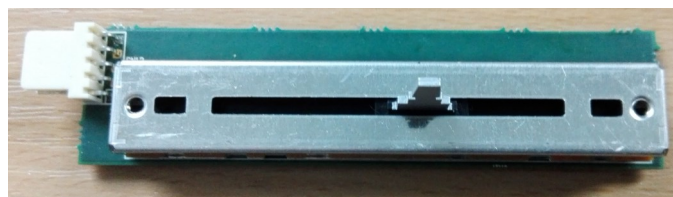

The innoFADER Pro2, from Audio Innovate, is also fully compatible as a cross-fader upgrade for the XONE:PX5. For details of innoFADER Pro2 stockists, and setup and calibration options, please visit the innoFADER website: www.innofader.com

REPLACING THE FADERS continued

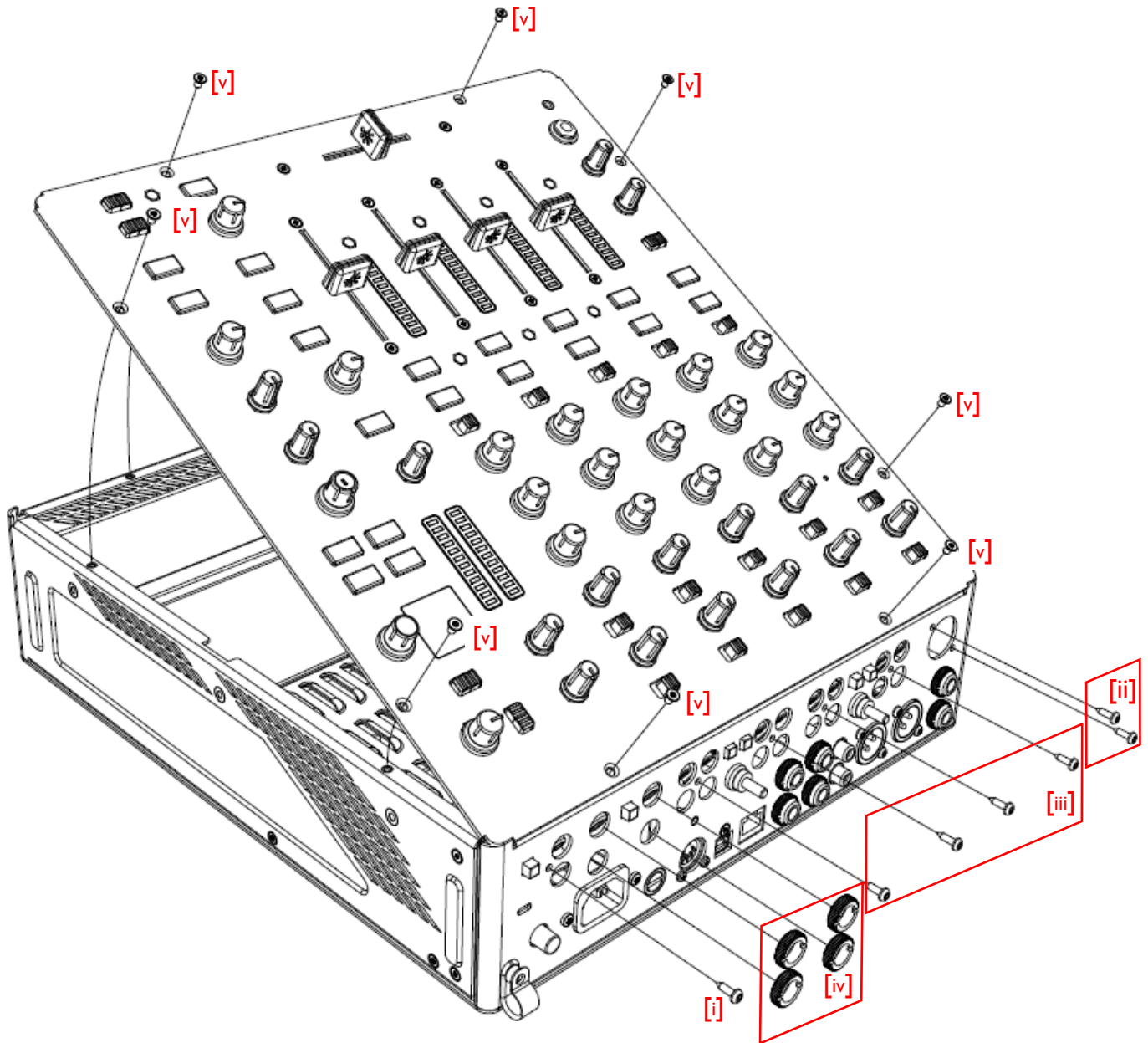

Step 1:

- Ensure power switch on the mixer's rear panel is turned **OFF**.
- Disconnect the mains cable from AC mains supply and mixer's IEC socket.

Step 2:

- Remove and retain 1 Torx screw securing, **RECORD**, RCA sockets to the rear panel [i].
- Remove and retain 2 Torx screws securing the rear panel **MIC**, XLR socket [ii].
- Remove and retain 4 Torx screws between **LINE** and **PHONO** RCA sockets on rear panel [iii].
- Remove and retain 4 circular nuts securing, **EXT RTN / FX SEND**, TRS (1/4" Jack) sockets [iv].

Step 3:

- Remove and retain 8 Torx screws securing top panel to the mixer chassis [v].

Step 4:

- Lift the **front edge** of the top panel up from the chassis, as illustrated above, to access and disconnect the internal harnesses (see below).

NOTE: Do not yet attempt to completely separate the top panel and chassis.

REPLACING THE FADERS continued

Step 5:

- With care, unplug 4, grey, flat harnesses and 1, orange, wire-form connecting the main top panel PCBA to the PCBA fixed to base of the mixer chassis, following the order shown below;

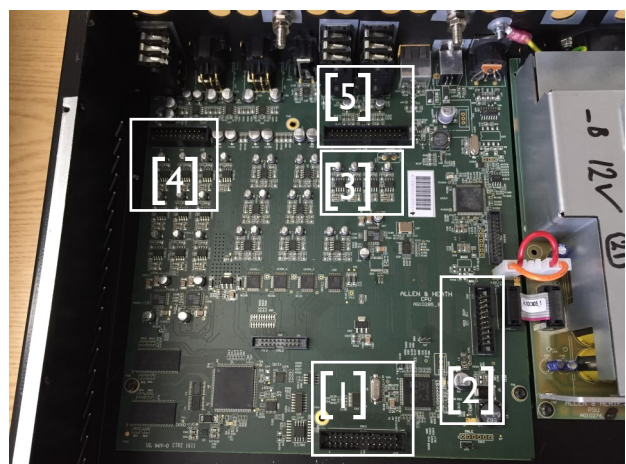
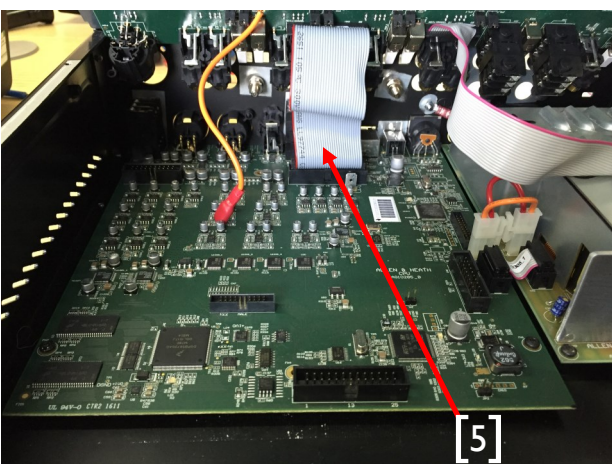
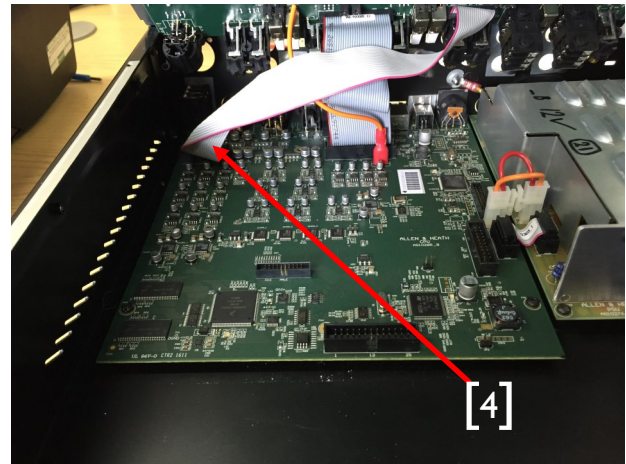
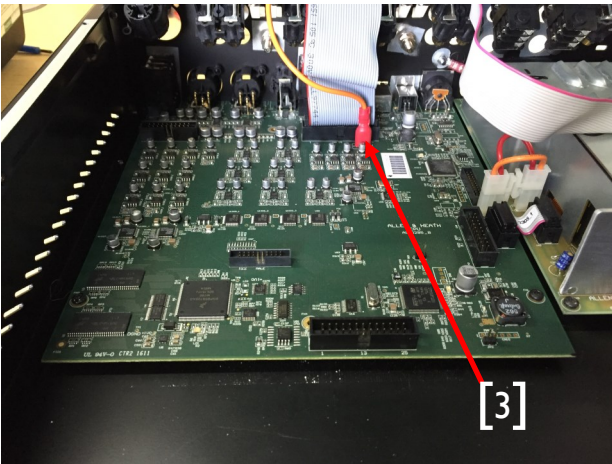
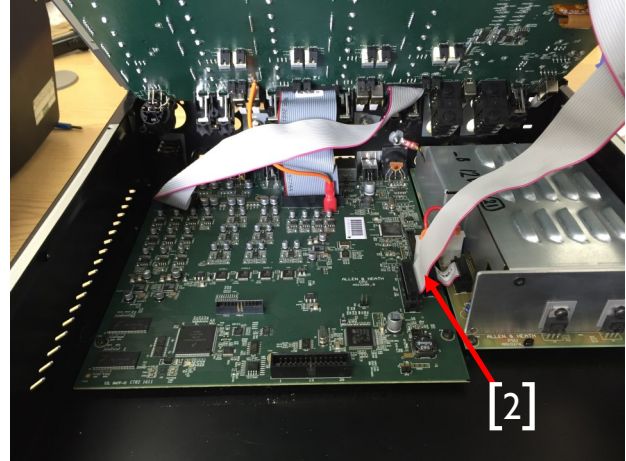
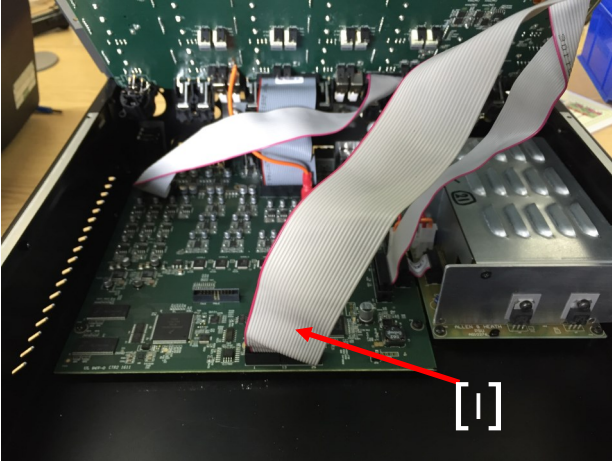

- The top panel can now be lifted away and separated from the chassis.
- Place the top panel face-down on a clean surface, taking care not to damage harnesses.

NOTE: when re-assembling the mixer, take great care to refit harnesses in correct positions and to ensure that connectors are fully fitted into their corresponding sockets.

REPLACING THE CROSS-FADER

Step 6: To replace the cross-fader

- With care, disconnect the black wire-form connecting cross-fader to the main PCBA.

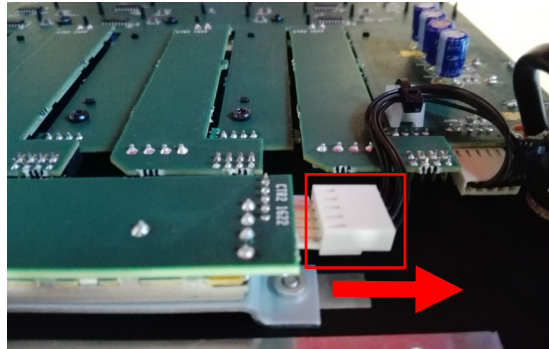

- Turn the top panel face up. Remove and retain 2 screws securing cross-fader tray to top panel



- Take the knob off the cross-fader shaft to remove the tray clear from the top panel



- Remove and retain 2 screws securing the cross-fader PCBA to the tray
- Fit the new replacement cross-fader PCBA to the bracket as shown below; slot [1]. The standard cross-fader must be fitted to slot [1] and **not** slot [2].



The longer slot [2] is for mounting the optional innoFADER Pro2 (not supplied).

- Screw the cross-fader plate back to the console.
- Replace the cross-fader knob.
- Re-connect the black wire-form from connecting cross-fader to the main PCBA.
- Reassembly of the mixer is the reverse of Steps 1 - 5, detailed above.

NOTE: when re-assembling the mixer, take great care to refit harnesses in correct positions (shown in Step 5 above) and to ensure that connectors are fully fitted into their corresponding sockets.

REPLACING THE CHANNEL FADER

Step 7: To replace the channel faders

- Remove the cross-fader tray prior to replacing channel fader/s, as described in Step 6 above.
- Remove and retain 2 screws securing the channel fader PCBA.

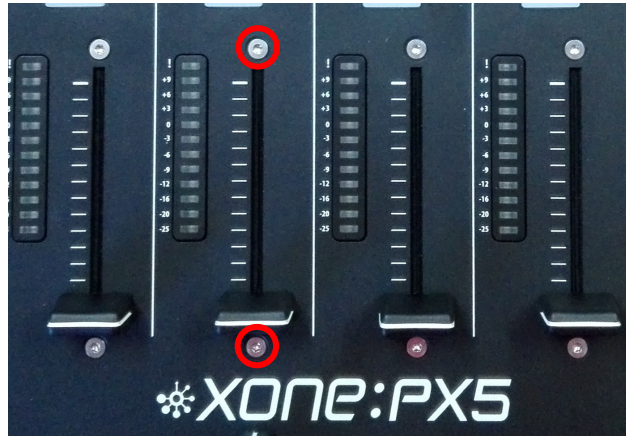

- Turn the top panel over and slide the Channel Fader PCBA away from its connection to the main top panel PCBA as shown.

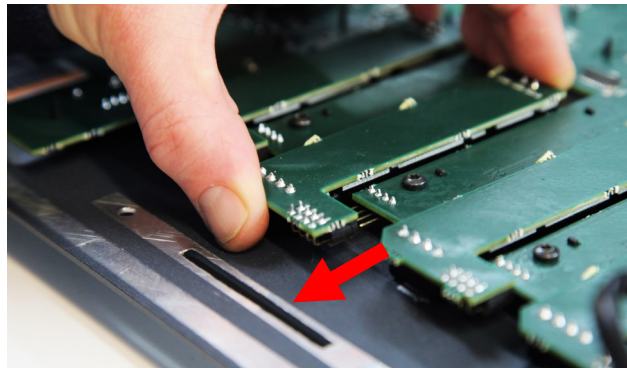

- Take the cap off the Channel Fader shaft to remove the assembly clear from the top panel.
- Fit the new replacement Channel Fader assembly to the main top panel PCBA.
- Ensure that pins on the main top panel PCBA fit correctly to the Channel Fader PCBA connector, as illustrated below.

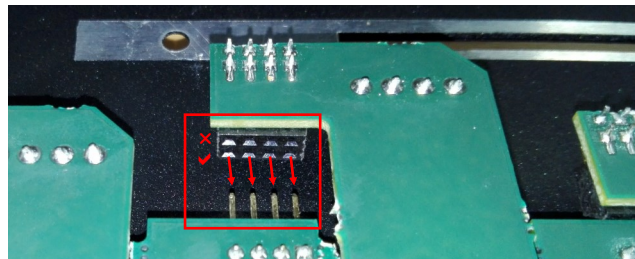

- Turn the top panel over, replace the Channel Fader knob.
- Screw the Channel Fader back to the top panel.
- Refit the cross-fader tray back to the console and replace the cross-fader knob.
- Re-connect the black wire-form connecting cross-fader to the main PCBA.
- Reassembly of the mixer is the reverse of Steps 1 - 5, detailed above.

NOTE: when re-assembling the mixer, take great care to refit harnesses in correct positions (shown in Step 5 above) and to ensure that connectors are fully fitted into their corresponding sockets.

For more information, please visit our website: www.allen-heath.com